



Name: \_\_\_\_\_

Week 17  
Kindergarten



Trace.

Write.

Write.

add

one

fall

has

was

_____	_____
-----	-----
_____	_____
_____	_____
_____	_____
-----	-----
_____	_____
_____	_____
_____	_____
-----	-----
_____	_____
_____	_____

Name: \_\_\_\_\_

Week 17  
Kindergarten



**fall**

f a l l l l x b f a l l m f

**add** d d a d d d l i d d x a m w



**one**

n q p i e n o n e z e n u n

**has** a n h d h m h a a z s h a s

**was** r a j u n w a z s d w a s m



**ONE**

R O O A N O X O N E J A U O

**ADD** L I D K A H A D D G I D D T

Name: \_\_\_\_\_

Week 17  
Kindergarten

Color in the boxes.

add = yellow, one = green,  
was = green, has = orange,  
fall = yellow

What is the hidden number? \_\_\_\_\_

has	fall	add	add	was
fall	one	was	has	add
fall	has	one	has	add
add	one	has	was	fall
fall	has	has	has	fall
add	has	one	one	fall
was	add	add	add	has

Circle the spelling words.

hasfalloneaddwasfalladdhaswasonehasonewasadd  
addaddwaswasoneoneoneonewashashasaddfallfall  
onefallwashasonewasaddaddwasoneaddhashasone

Name: \_\_\_\_\_

Week 17  
Kindergarten

s a i h a a w l e s l e  
f d w h a s d l t d a w  
s j o h p o h a w h s o  
g s s j n s m d a a a n  
w l e h a a o d i f s e  
d h a s d v d v e s j h  
k w a s d n s w n q d n  
q f a l l d m f a d p n



fall



was →



one ↓

has →

add ↓

short u and long u

drums



monkey



lion

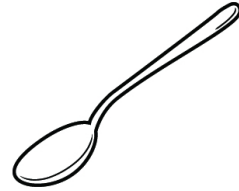

ladybug

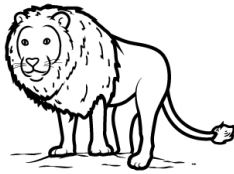

spoon



soup



into

afraid

money

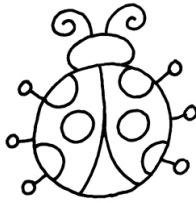

vacuum

stool

thumb

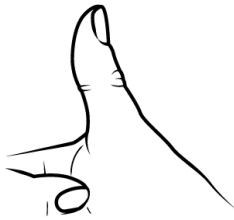



begins with s sound

begins with t sound

trophy



skate

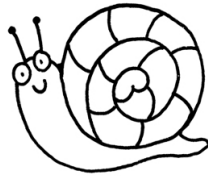

saw



tank

tie

two



stomach

toast

snail

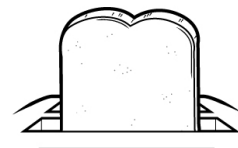

train

stump

sleep

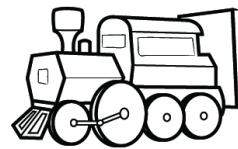





Name: \_\_\_\_\_

# The first letter is ...



ump



wo



leep



kate



tomach

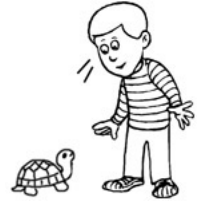

aw

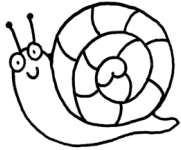

nail

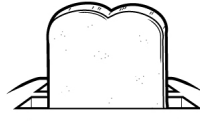

oast



ank



rophy



ie

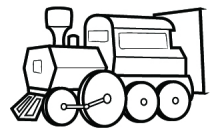

rain

Name: \_\_\_\_\_



tie

t i k l t i e z q c v i u e b t e u f

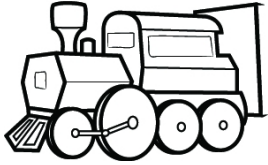

train

r t a t v a j c t r a i n t r a n t a

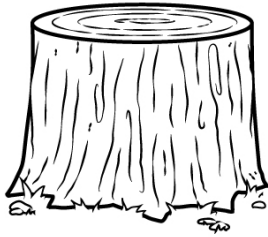

stump

i h m u w e s t u m p v r a s t e m p

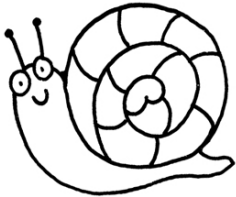

snail

l s y i i s n a i l s n a l l a a l i



sleep

w p s l e e p s p l e e p a e p e l e



saw

w k l z s w s i w a t s a w f a q y b

Name \_\_\_\_\_

# Sight Words

Week  
17

Say them (in black) and repeat (in gray)!

one  one one one one

has has has has has

was was was was was

fall  fall fall fall fall

 S-o-u-n-d It Out

add  add add add add

Name \_\_\_\_\_



# Rapid Review

Week  
17

Follow the arrows to say your new words (in black) and your \*review words (in gray)!

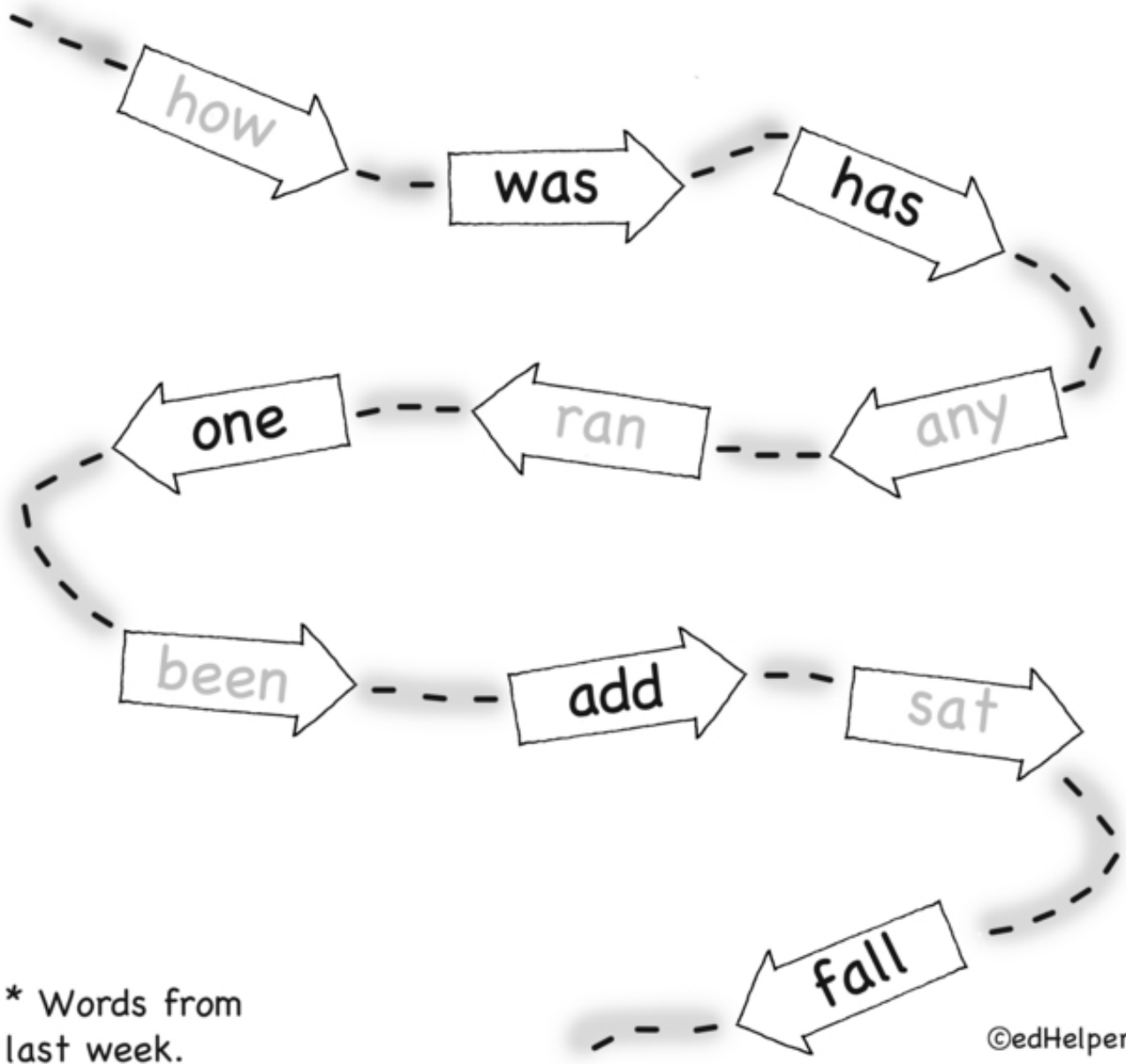

\* Words from last week.

Name \_\_\_\_\_



Color... one - purple  
has - yellow  
was - pink  
add - brown  
fall - red

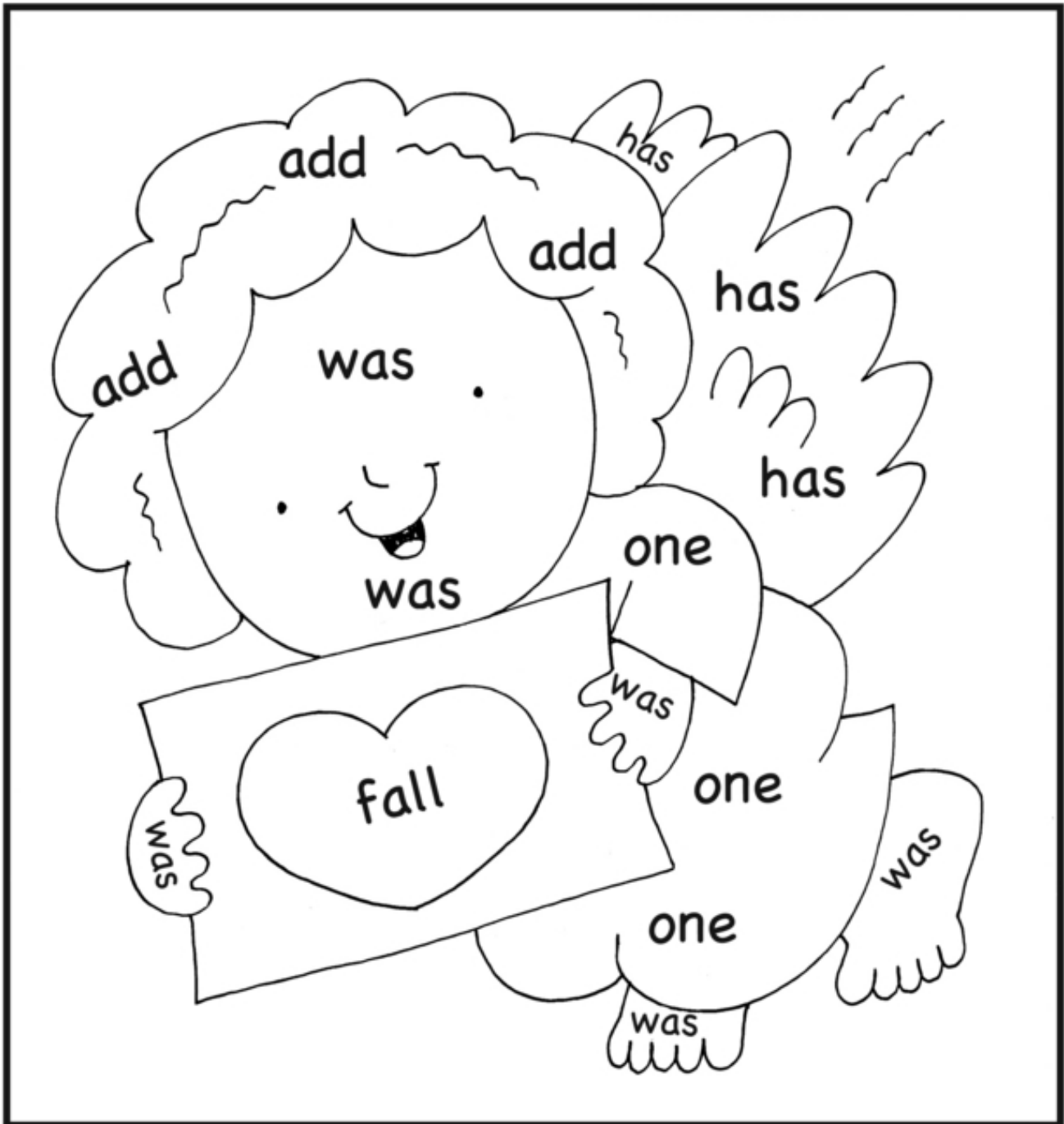

Name \_\_\_\_\_

Correct Cards



Fill in the missing letters on the envelopes so they spell the same word on the valentines next to them.



\_\_ a \_\_ l



wa \_\_



h \_\_ s



\_\_ \_\_ e



a \_\_ \_\_

Name \_\_\_\_\_

## Sentence Sense



Point to the word that will fill the blank.

1. Yesterday \_\_\_\_\_ when we started Valentine's Boxes.

one

2. I am the only \_\_\_\_\_ who is almost done.

has

3. I \_\_\_\_\_ a big cupid to the top.

was

4. Also, mine \_\_\_\_\_ many hearts.

add

5. My teacher will \_\_\_\_\_ in love with it!

fall









Name: \_\_\_\_\_

Week 18  
Kindergarten



yes

y y o **y e s** y u h s h k s e

**must** m u c t m u s t w y z u t m

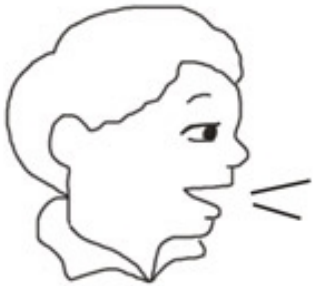

say

a y s a y z s a y y m t v e

**our** h u x n t o o u r i o r u o

**tub** b a w u f t s b t u b t e b

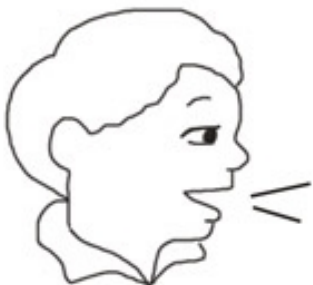

SAY

R G Y S A Y T S F S A A Y J

**MUST** M U S T E M U H S V T N I K

Name: \_\_\_\_\_

Week 18  
Kindergarten

Color in the boxes.

tub = yellow, must = purple,

yes = blue, say = green,

our = pink

What is the hidden number? \_\_\_\_\_

must	must	must	must	must	must	tub
must	our	yes	tub	say	must	say
must	tub	say	our	yes	must	our
must	must	must	must	must	must	yes
tub	say	tub	say	tub	must	say
yes	our	yes	our	yes	must	tub
our	tub	say	tub	say	must	say
say	yes	our	yes	our	yes	our

Circle the spelling words.

yessaytubmustouryesourtubmustsayourmusttubyes

musttubouryestubtubsayourourmustyessaysayyes

ourtubyessaymustouroursaytubtubmustmustyestub

Name: \_\_\_\_\_

Week 18  
Kindergarten

y u m u s y y h o g g y  
k g u z c u y s y s r s  
t e s b i p o u r m k a  
y t t e c t a y t s s t  
n r t v y t y u u u s u  
m a e y r o u l b r f s  
m y e s t n u f m o l u  
m t m m s a y e l t t a

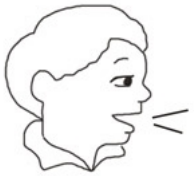

say



tub ↓



yes



our →

must ↓

short o and long o

fox

going

box

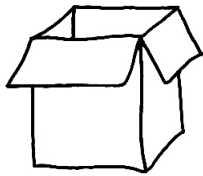

knot

trophy

hot



mailbox

clover

snow

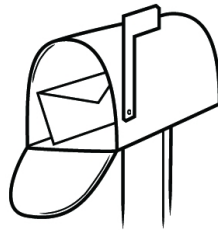
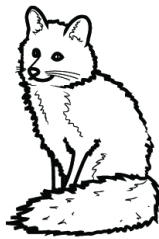

globe





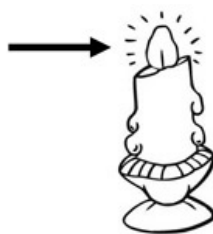
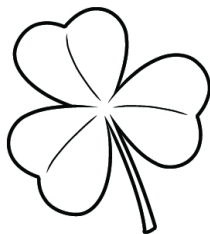

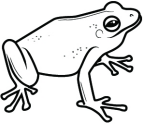

know

rock



Name: \_\_\_\_\_

short o and long o

begins with g sound

begins with r sound

ran



give



ghost



run



going



roses

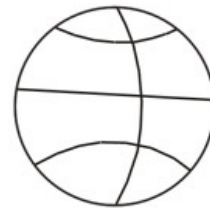

gate



round

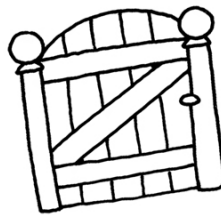

rug



good



rake



read

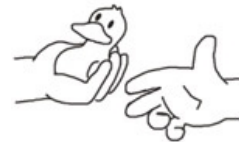





Name: \_\_\_\_\_

# The first letter is ...



un

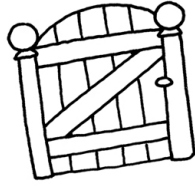

ate



oo



ake



ead



oing



host



oses



an

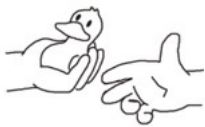

ive



ound



ug

Name: \_\_\_\_\_

**good**

d g b g o o g o o d g o d f o g u o d

**ran**

r a n r e n q g u w r k n a a s n r z

**going**

a g o i n g t y k g o n i g i q b d i

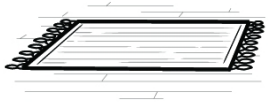
**rug**

u q r u u h g r o f r u g m t p y r i

**give**

v o x g g i v i v t q s e g i v e a m

**round**

n u o u n n r o u n f q i r r o u n d

Name \_\_\_\_\_

# Sight Words

Week  
18

Say them (in black) and repeat (in gray)!

say

say say say say

our

our our our our

yes

yes yes yes yes

must must must must must

 S-o-u-n-d It Out

tub



tub tub tub tub

Name \_\_\_\_\_



# Rapid Review

Week  
18

Follow the arrows to say your new words (in black) and your \*review words (in gray)!

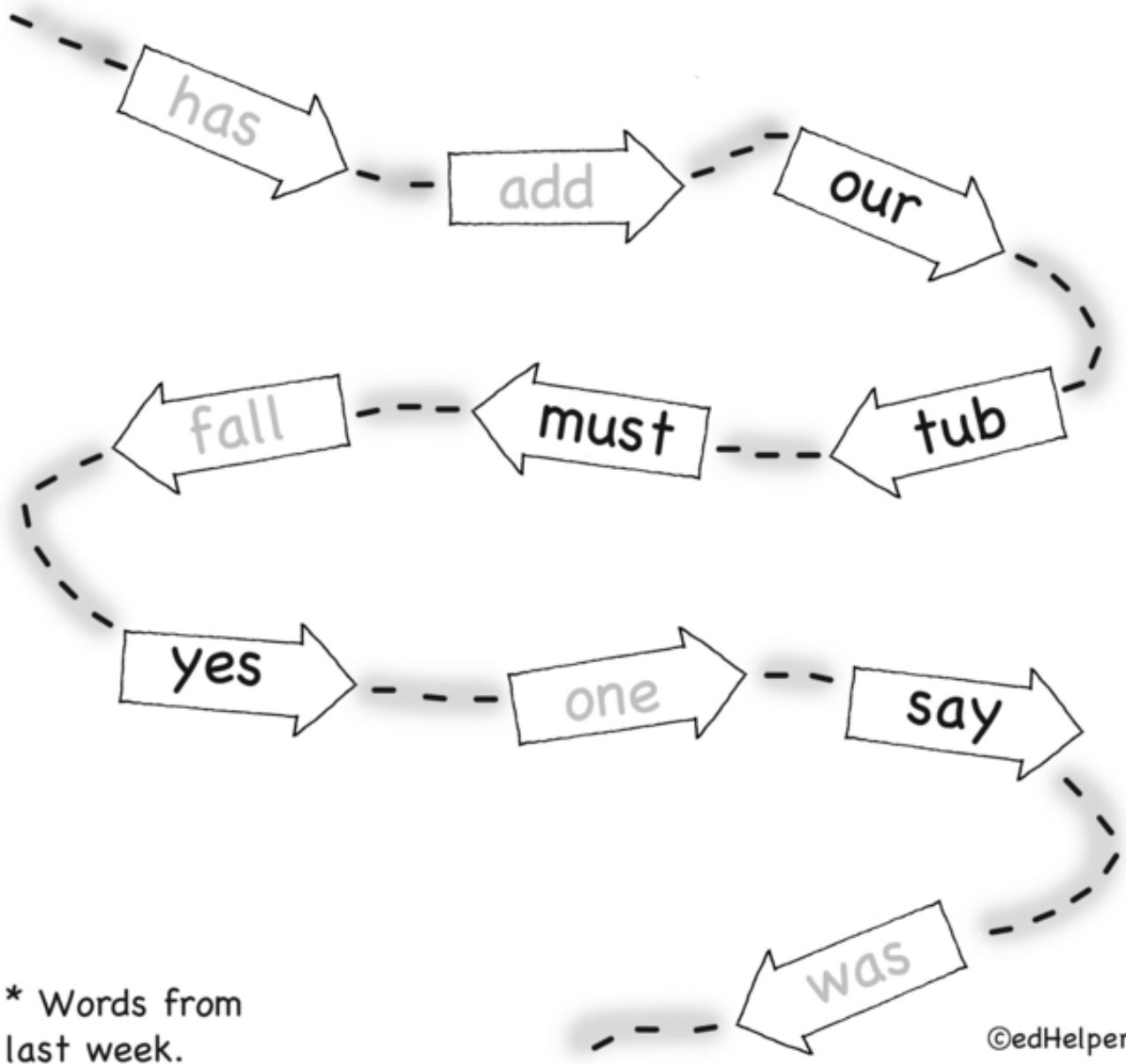

\* Words from last week.

Name \_\_\_\_\_



Color... say - gray  
our - red  
yes - pink  
tub - purple  
must - blue

Week  
**18**

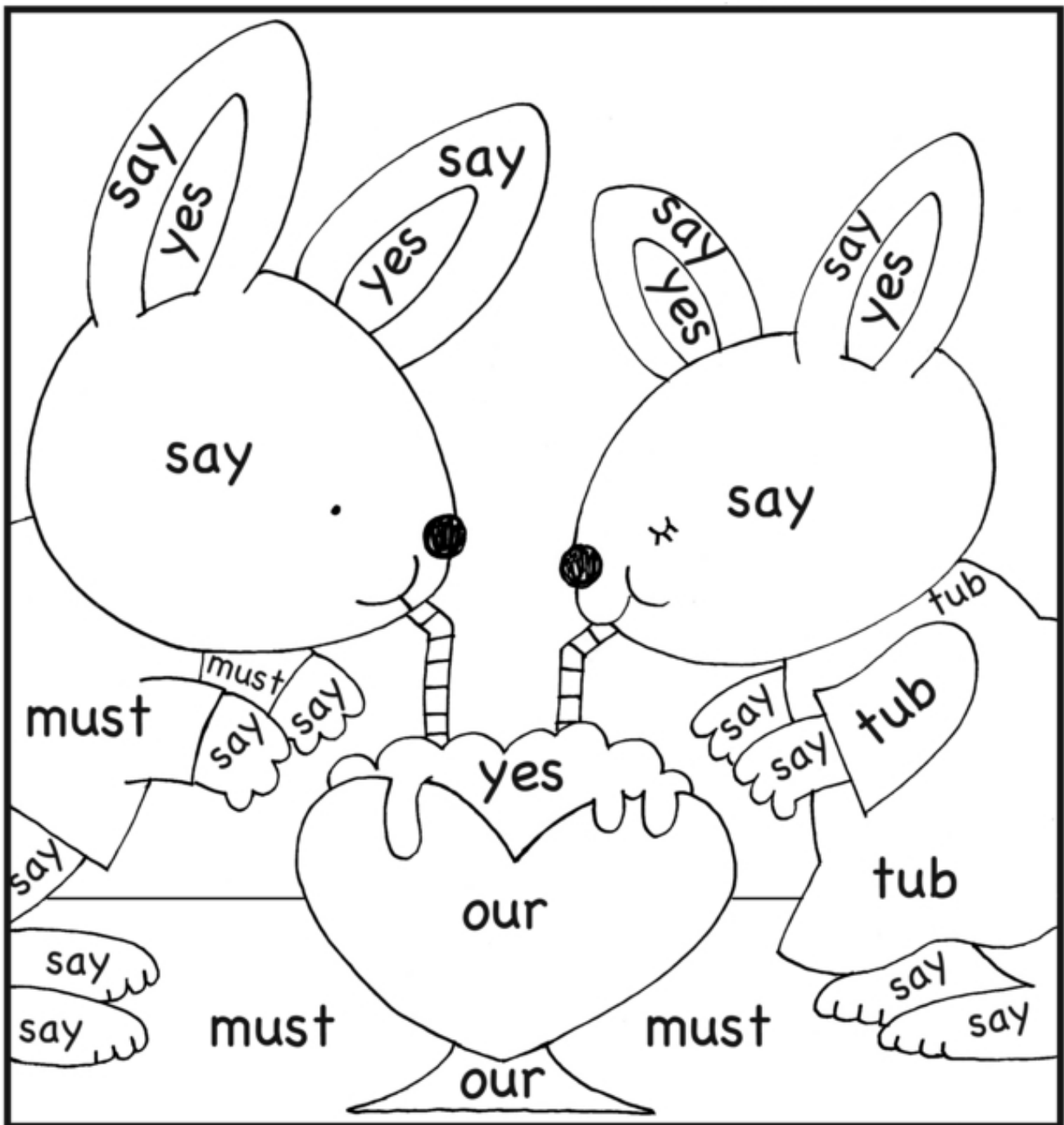

Name \_\_\_\_\_

Scroll

Goal

Week  
18

Each of these words are spelled backwards.  
Rewrite them correctly onto the blanks.



Name \_\_\_\_\_

## Sentence Sense



Point to the word that will fill the blank.

1. I knew \_\_\_\_\_ dog needed a bath.

2. So I filled his \_\_\_\_\_.

3. I can't \_\_\_\_\_ he looked happy.

4. I said, "You \_\_\_\_\_ do this!"

5. He nodded \_\_\_\_\_, and got in.

say

our

yes

tub

must





Name: \_\_\_\_\_

Week 19  
Kindergarten



# SPELLING



Trace.

ANT

Write.

Write.

ASK

OUT

LIVE

SAW

<hr/> <hr/> <hr/>	<hr/> <hr/> <hr/>
<hr/> <hr/> <hr/>	<hr/> <hr/> <hr/>
<hr/> <hr/> <hr/>	<hr/> <hr/> <hr/>
<hr/> <hr/> <hr/>	<hr/> <hr/> <hr/>
<hr/> <hr/> <hr/>	<hr/> <hr/> <hr/>



Name: \_\_\_\_\_

Week 19  
Kindergarten

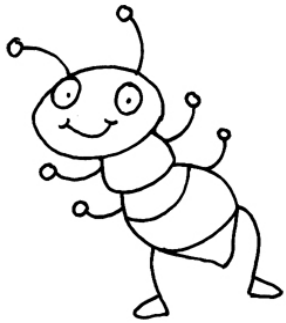

ant

t a j a a n t **a n t** n z d a

ask n i s k r a s k t o a s k s



live

v i o l v i e m v l i v e l



out



u o t t r o o u t u p w u n



saw

o s u w u l q y s a w d t a

Name: \_\_\_\_\_

Week 19  
Kindergarten

Color in the boxes.

live = purple, ask = green,  
saw = black, out = orange,  
ant = yellow

What is the hidden number? \_\_\_\_\_

saw	ask	ask	ask	ask	ask	out
out	ask	ant	live	out	live	ant
ant	ask	out	saw	ant	saw	out
live	ask	ask	ask	ask	ask	ant
ant	out	ant	live	saw	out	ask
saw	live	saw	out	ant	live	ask
out	ask	ask	ask	ask	ask	out
live	saw	ant	live	saw	ant	saw

Circle the spelling words.

asksawliveoutantlivesawantaskoutliveoutantsawask  
asksawaskawoutoutantlivelivesawoutliveoutantant  
sawsawlivesawaskantsawantoutliveoutliveoutantlive

Name: \_\_\_\_\_

Week 19  
Kindergarten

a s k i w b y o a s t v  
l l s e l i o n p v v v  
g y d l i v e n a s o q  
a w i t l a i m v j d v  
t h o t j t a n t v e s  
t a n v s z l v t o t r  
n l z n t t b l u s a w  
b o u t n n w s u a u c



out  
→

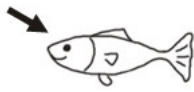

live  
→

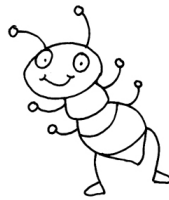

ant  
→

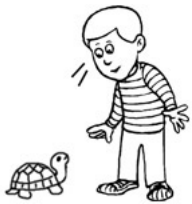

saw  
→

ask →

short e and long e

chest



key

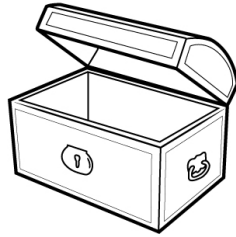

bell



wheel

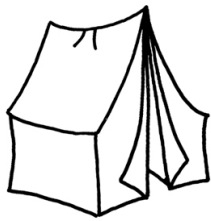

keep



tent

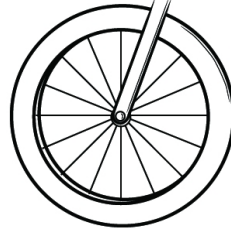

umbrella



get

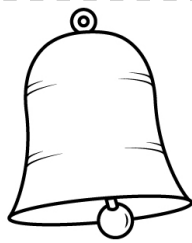

seven



eleven



yes

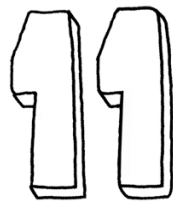

said





begins with b sound

begins with g sound

black



good



boxes



bat

globe



bite



get

garden

blue

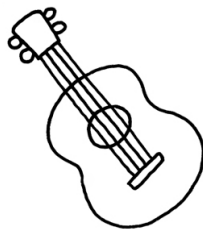

goat

guitar

goes









Name: \_\_\_\_\_

# The first letter is ...



et



oat



lack

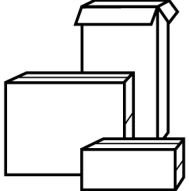

oxes



oes



ood



uitar



ite



at



arden



lue



lobe

Name: \_\_\_\_\_

**black**

k q a c k w c b l a c k b a l c k o a

**blue**

e a k i b e z l y m b l u s b l u e j

**garden**

a a g o r d a n g a i v g a r d e n n

**globe**

g l o b e e b g l o b e l o e o l g e

**good**

z g o o d o g a o d o o l s p t o d j

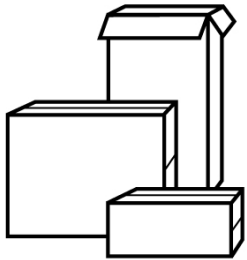
**boxes**

d q b o x e x v b b o x e s e e t b m

Name \_\_\_\_\_

# Sight Words

Week  
19

Say them (in black) and repeat (in gray)!

**saw** saw saw saw saw

**out** out out out out

**ask** ask ask ask ask

**live** live live live live

 S-o-u-n-d It Out

**ant**  ant ant ant ant

Name \_\_\_\_\_



# Rapid Review

Week  
19

Follow the arrows to say your new words (in black) and your \*review words (in gray)!

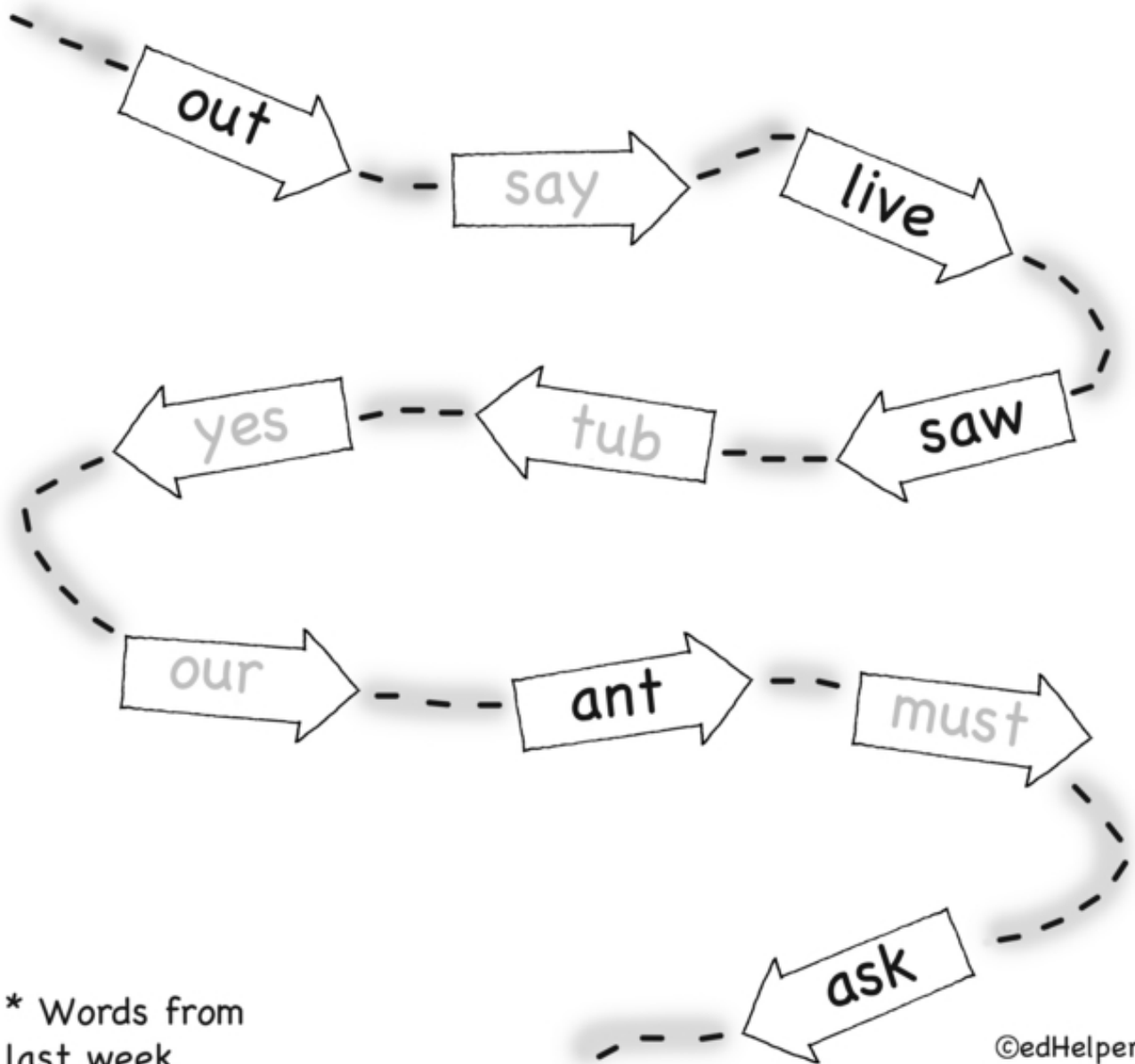

\* Words from last week.

Name \_\_\_\_\_



Color... saw - yellow  
out - blue  
ask - purple  
ant - brown  
live - red

Week  
**19**

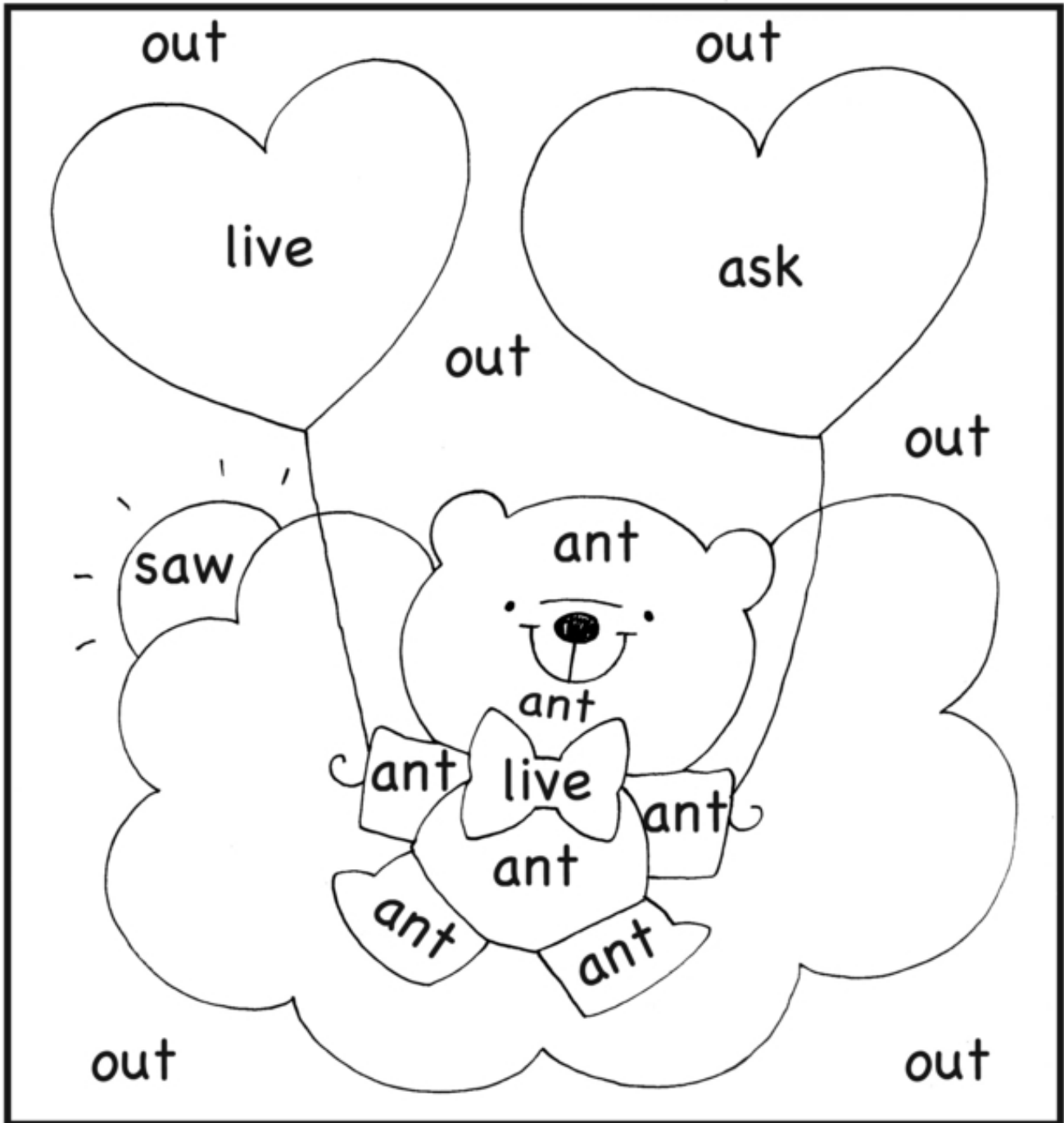

Name \_\_\_\_\_

Tasty

Tracing

Week  
19

Trace over the gray words only if they are spelled like the ones above them.



Name \_\_\_\_\_

## Sentence Sense



Point to the word that will fill the blank.

1. In the paper, I \_\_\_\_\_ the zoo had a new polar bear!

saw

2. We \_\_\_\_\_ two blocks away.

out

3. When we arrived she was \_\_\_\_\_ in the snow.

ask

4. I wanted to \_\_\_\_\_ her if she was happy here.

ant

5. I must look like an \_\_\_\_\_ to her!

live









Name: \_\_\_\_\_

Week 20  
Kindergarten



dog

d o o g g g d d **d o g** g y u

let m l e h t p l l e t e e w a



sit

w s i t t v s i t t c i q k



have

h e v a v h a v e h d p h b



her

h h u r h e g i e h e r e k

Name: \_\_\_\_\_

Week 20  
Kindergarten

Color in the boxes.

have = pink, dog = orange,

her = orange, sit = pink,

let = green

What is the hidden number? \_\_\_\_\_

let	let	dog	her	her	her	dog	dog
have	sit	her	let	let	sit	sit	dog
let	have	her	have	let	let	let	her
sit	have	dog	her	dog	her	dog	her
let	let	let	have	let	sit	let	her
sit	let	let	have	let	sit	have	her
let	have	sit	let	have	sit	let	her
sit	let	have	have	let	sit	have	let

Circle the spelling words.

letsitherhavedoglethavehersitdogherhavesitdogletsit

haveletdogletdoghaveherhersitdoglethersithavesitsit

herlethavehavedogsitherlethavehavesitdogsitletdog

Name: \_\_\_\_\_

Week 20  
Kindergarten

t e l s h a v e s r h s  
d d e o r g e h m e e r  
s h t s w d e e s v d e  
t l c i h h a v e e o k  
r h e t h p r y o b g s  
t o l a p t h e d e a t  
r u k t k d t l r g i n  
t l d r h e r b s d i o



her  
→



sit  
↓



have  
→



dog  
↓

let  
↓

short i and long i

sky



smile

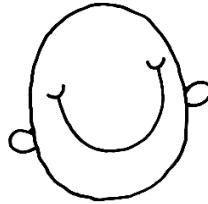

going



sing

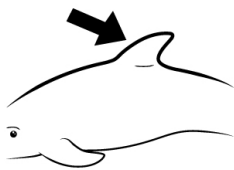

fin



five

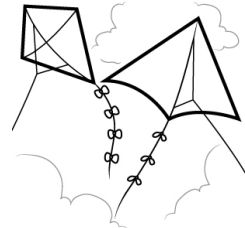

slide



fish



mitten



idea

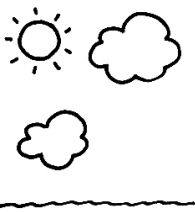

kites

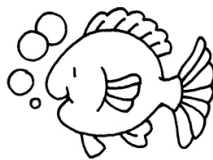

pingpong

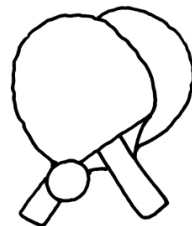



begins with s sound

begins with r sound

saw



six



rabbit

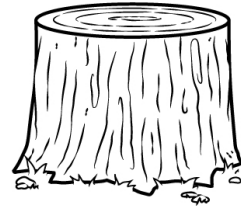

scarecrow



rain

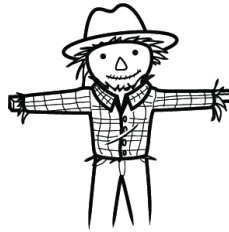

soup

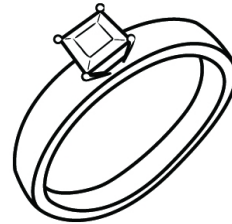

swing



sock

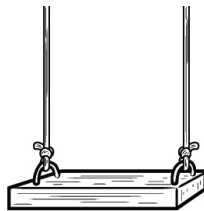

rings

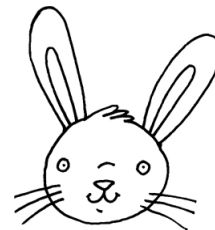

ring



stump



round

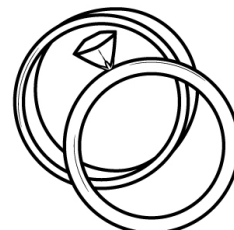





Name: \_\_\_\_\_

# The first letter is ...



ing

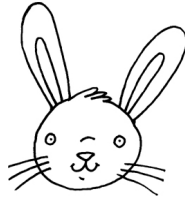

abbit



ock



ain

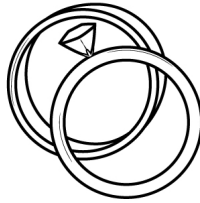

ings



ix



ound



oup

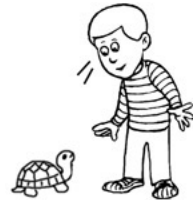

aw

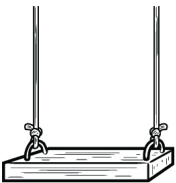

wing



carecrow

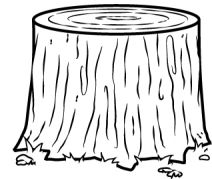

tump

Name: \_\_\_\_\_

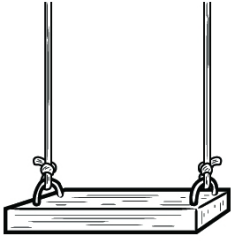

swing

i s w i n g w s p g s w i h n s t w i



rain

h r r a i n g x f r v s n b r i y n n



round

n e i u r o u n d u o d o u n d j u n

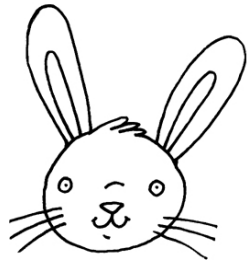

rabbit

c y t r a b b i t g r a b i i t f i n



soup

s o u p o o s u o z f u o a v s u o p



scarecrow

b c o s a r s c a r e c r o w d s e l

Name \_\_\_\_\_

# Sight Words

Week  
20

Say them (in black) and repeat (in gray)!

let                      let let let let

her  her her her her

sit  sit sit sit sit

have                      have have have

 S-o-u-n-d It Out

dog  dog dog dog dog

Name \_\_\_\_\_



Color... let - purple  
her - brown  
sit - blue  
dog - gray  
have - yellow

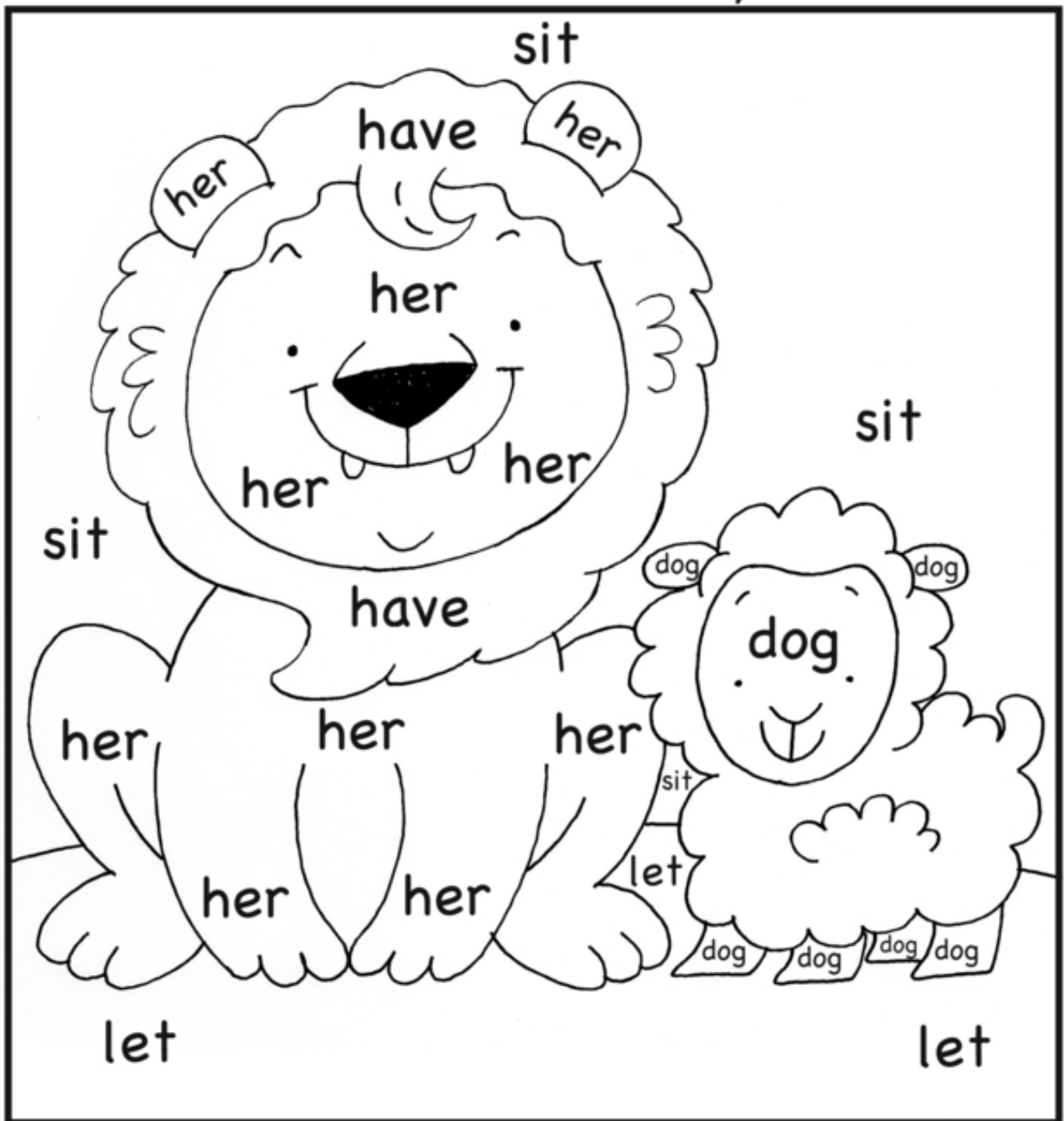

Name \_\_\_\_\_

# Showing Sheep

Week  
20

Draw lines from each lion to the sheep that show those same words.



Name \_\_\_\_\_

## Sentence Sense



Point to the word that will fill the blank.

1. Sadie watched my \_\_\_\_\_.

let

2. She taught him to \_\_\_\_\_.

her

3. Then she \_\_\_\_\_ him eat treats.

sit

4. Later, I asked \_\_\_\_\_ why my pet looked sick.

dog

5. She said "Sorry. I \_\_\_\_\_ fed him too much!"

have

