

Name: _____

Week 13
Kindergarten



six

i u p **s i x** i f e x s i i x

bug o b u g a u b u b e b a h g



cold

g l c o o l d c o l d o o c



ten

t c t a h n l h j t f t e n



wash

l w x a r w w a s h w a c h

Name: _____

Week 13
Kindergarten

Color in the boxes.

six = black, cold = red,

bug = green, ten = purple,

buy = purple, wash = blue

What is the hidden number? _____

cold	bug	wash	six	cold	six	cold	six
wash	six	cold	bug	wash	bug	wash	bug
ten	buy	ten	buy	buy	ten	six	cold
buy	cold	wash	bug	six	cold	wash	bug
ten	bug	six	cold	wash	bug	six	cold
ten	ten	buy	buy	ten	ten	wash	bug
buy	six	bug	wash	bug	ten	cold	six
buy	wash	cold	six	cold	ten	bug	wash
buy	ten	buy	ten	ten	buy	six	cold

Circle the spelling words.

buybugwashsixcoldtenbugcoldbuysixwashtenbuyten
sixcoldbuywashtenwashcoldwashbugtenbuybuysixsix
tntenbugbuybugbugwashbugcoldwashcoldbuyten

Name: _____

Week 13
Kindergarten

u m b w a s j s g g b x
s h b g b d d w v c u l
a t x o g u b l z o g s
k g w a s h u a x l s y
a l s t l u m i l d s t
c b m m n c u n u u e e
n e b u y q t n i s i n
b u r b l l a s b s i x



buy



6

six



cold ↓



wash



10

ten ↓

bug ↓

pie

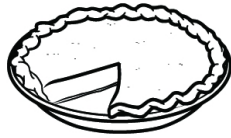

kites

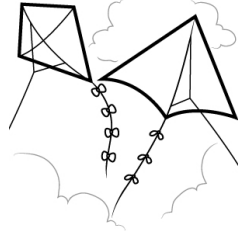

ship

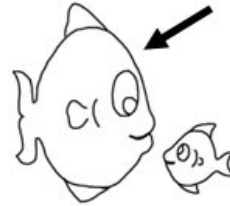

fly

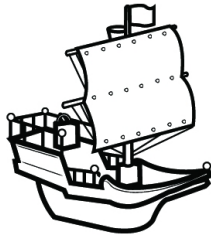

guitar



big

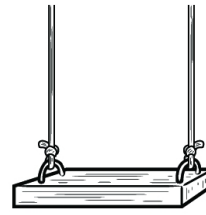

ride

whistle

kite

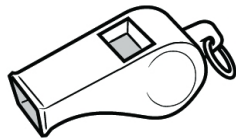

dice

nine

swing

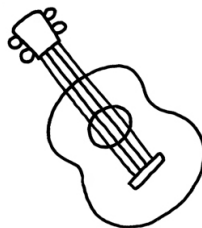
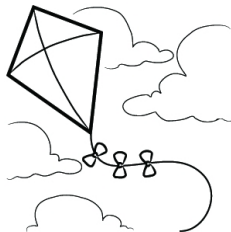

begins with h sound

begins with p sound

him



her



pick

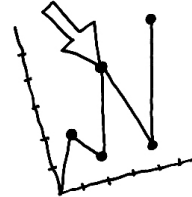

pull

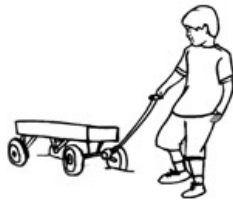

party



happy

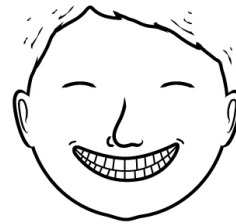

hole

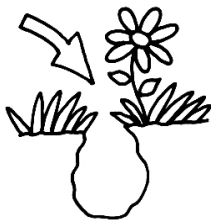

point



puppy



pocket

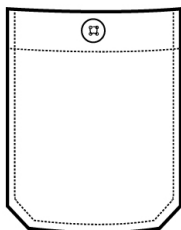

paint



hurt



Name: _____

The first letter is ...



aint



im



er



ole



arty



ick

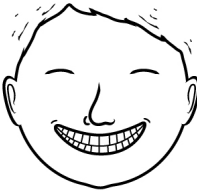

appy

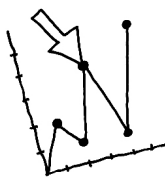

oint



ull



urt

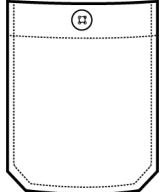

ocket



uppy

Name: _____

edHelper

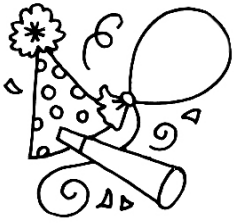

party

a p z r m p a r t y p a t r y n t y y



hurt

y h r u p z e h u r t c k j r h i r t



paint

i r t b p p p p o u n t p a i n t n d

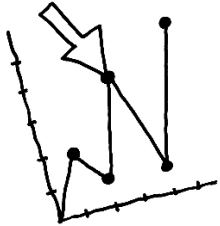

point

h n p i p u i n t p o i n t n w s p i

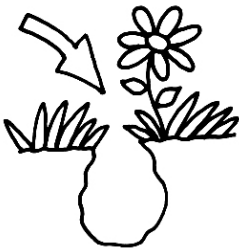

hole

v l h l o h l e f h h o l e n c e e o

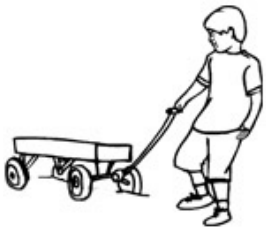

pull

o p u l l u u p p u l l y y g u l f l

Name _____

Sight Words

Week
13

Say them (in black) and repeat (in gray).

ten 

ten ten ten ten

six 

six six six six

buy

buy buy buy buy

wash 

wash wash wash



S-o-u-n-d It Out

bug 

bug bug bug bug

W-i-n-t-e-r Word

cold

cold
cold

cold
cold

Name _____



Rapid Review

Week
13

Follow the arrows to say your new words (in black) and your *review words (in gray)!

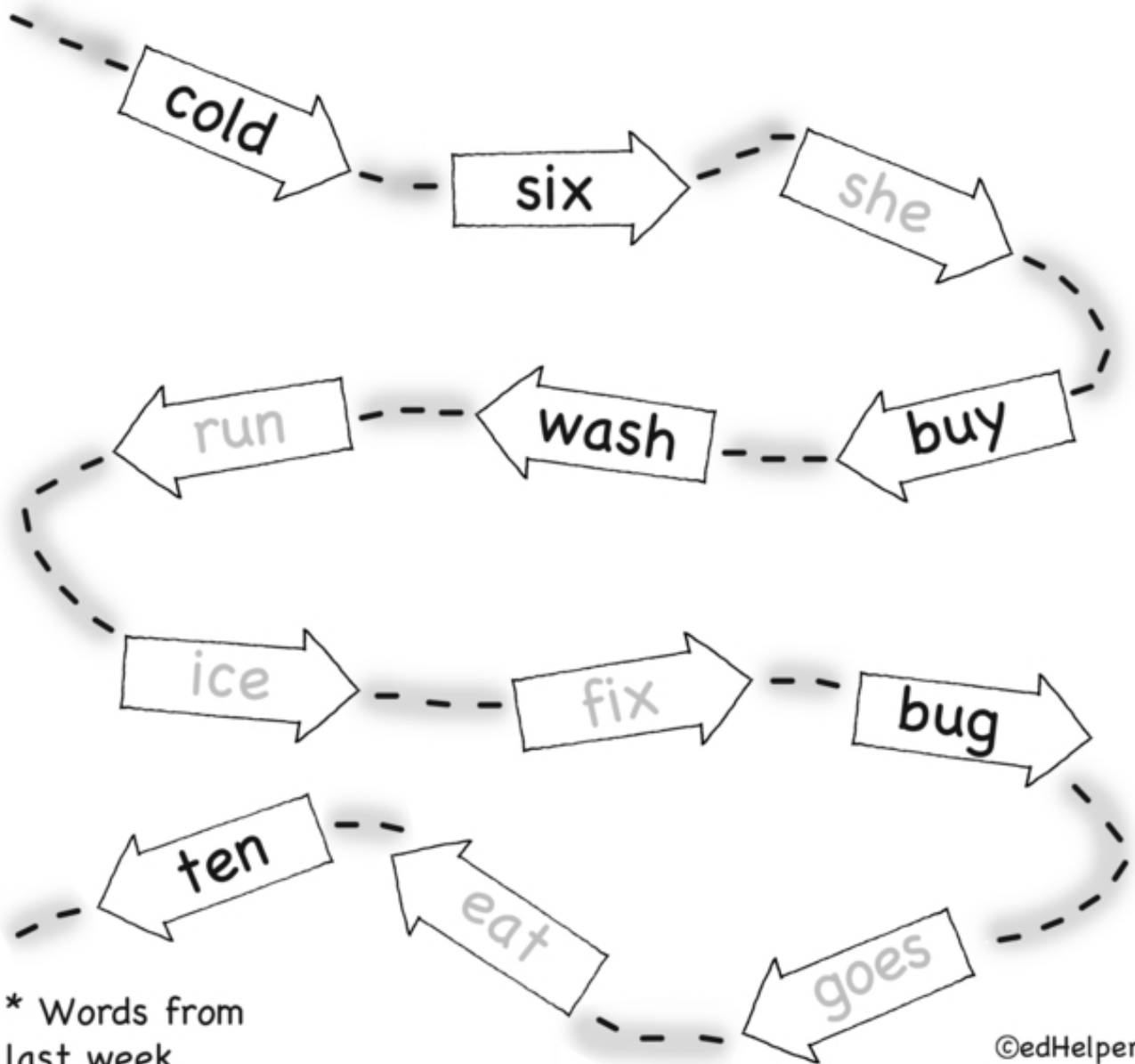

* Words from last week.

Name _____



Color...

ten - purple
six - pink
buy - green

bug - orange
wash - blue
cold - yellow

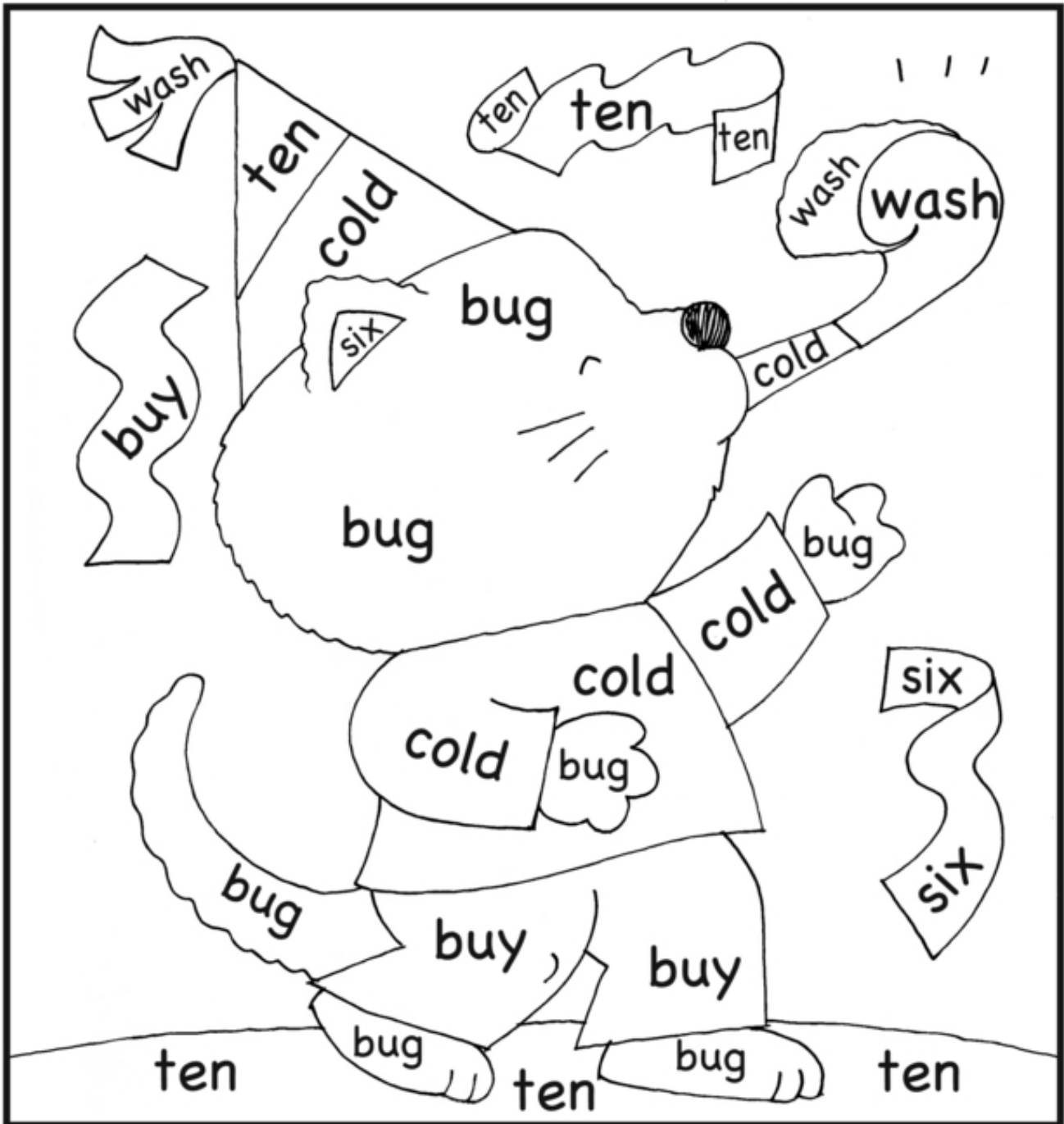

Name _____

Blizzard Blast

Week
13

Draw lines through the words that are spelled incorrectly. Underline correctly spelled words with a bright crayon color.



Name _____

Sentence Sense



Point to the word that will fill the blank.

1. Mom hired me to _____ the dishes.

2. I used the money to _____ candy.

3. I got _____ chocolate coins.

4. Outside the store I saw a freezing _____.

5. All _____ of his legs were shaking!

6. I gave him my bag so he wouldn't be _____.

ten

six

buy

wash

bug

cold



Name: _____

Week 14
Kindergarten



well

d m h p l w e w e l w e l l

try z r y t t r y p y t t r a i



jar

a j a r r r j j o r h i j q

and h a n d d n a n d o e j n a



snow

e s n o w e z w s n o w n v



get

j t g e t o g x t g e h g s

Name: _____

Week 14
Kindergarten

Color in the boxes.

get = yellow, well = red,

try = red, and = purple,

jar = black, snow = yellow

What is the hidden number? _____

try	well	try	well	try	well	jar
try	jar	and	snow	and	snow	get
try	snow	and	jar	jar	and	jar
try	well	try	try	try	well	snow
try	and	get	jar	get	well	and
try	jar	and	jar	and	well	get
well	try	try	try	well	well	jar

Circle the spelling words.

gettryandsnowjarwellandjargetsnowwelltrywelljartry
trygetwellgetandtrywelljarsnowsnowwelljarjarwelltry
jarwelltrygetjarsnowgettryjarwellwellandwelltryand

Name: _____

Week 14
Kindergarten

g j x e l x o d t v i l
w j n e a g g r e t y a
e t g r t p n g a n d k
l s s d w n c e o j a d
l n x a r d y t d a t l
j o g o n w r z t r w e
a w r t o a y l r e r y
a t n g g c l k y j n n



snow ↓



jar ↓



well ↓



get ↓

and →

try ↓

short a and long a

paint



happy



taste



magic



branch

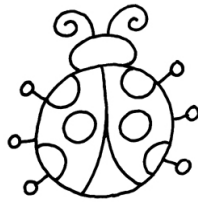

mask

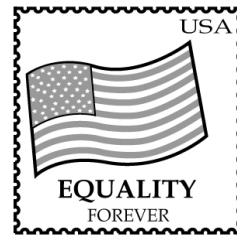

stamp



grapes



whale



ladybug



mad



hammer

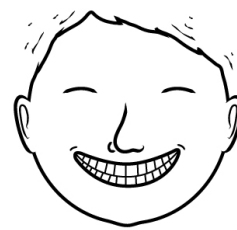

begins with p sound

begins with n sound

pear



patch



party

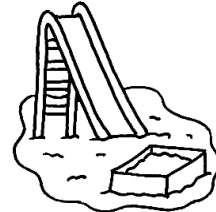

present



puppy



play

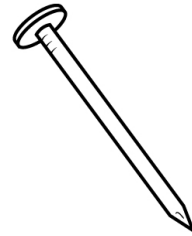

pingpong



nine



nail

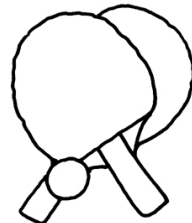

paper

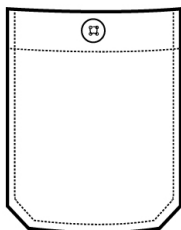

pocket



playground

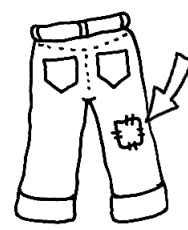

Name: _____

begins with p sound

begins with n sound

begins with p sound	begins with p sound	begins with n sound

Name: _____

The first letter is ...



ingpong



lay

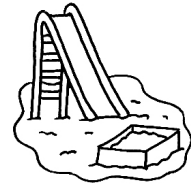

layground



ine

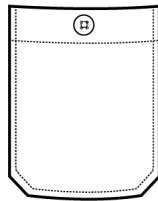

ocket

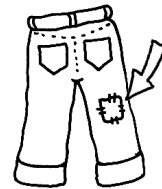

atch

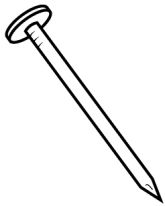

ail



uppy



resent



arty



aper



ear

Name: _____

edHelper

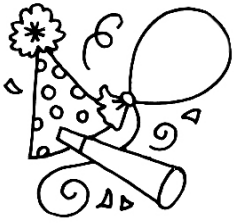

party

t t y p a r t y p n x m w p a r t y s

pingpong

j w p i n g p o n g d n u p g r g c o

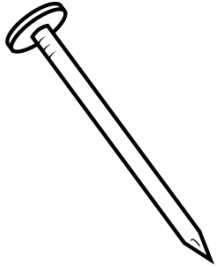

nail

n a i l c q l e n i u l p n a n d a s



paper

p p m b q a p a p e r p e p e r r j g

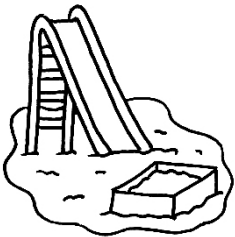

playground

y h y v l d u p p l a y g r o u n d a

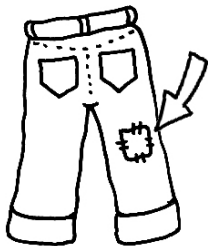

patch

o a l a p k p a f j p a t c h p a c h

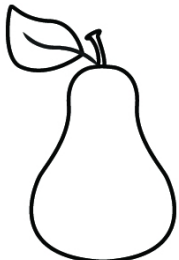

pear

i y p e h b m p e a r l w n e h z g r

Name _____

Sight Words

Week
14

Say them (in black) and repeat (in gray).

and

and and and and

try

try try try try

get

get get get get

well



well well well well



S-o-u-n-d It Out

jar



jar jar jar jar

W-i-n-t-e-r Word

snow



snow

snow

snow

snow

Name _____



Rapid Review

Week
14

Follow the arrows to say your new words (in black) and your *review words (in gray)!

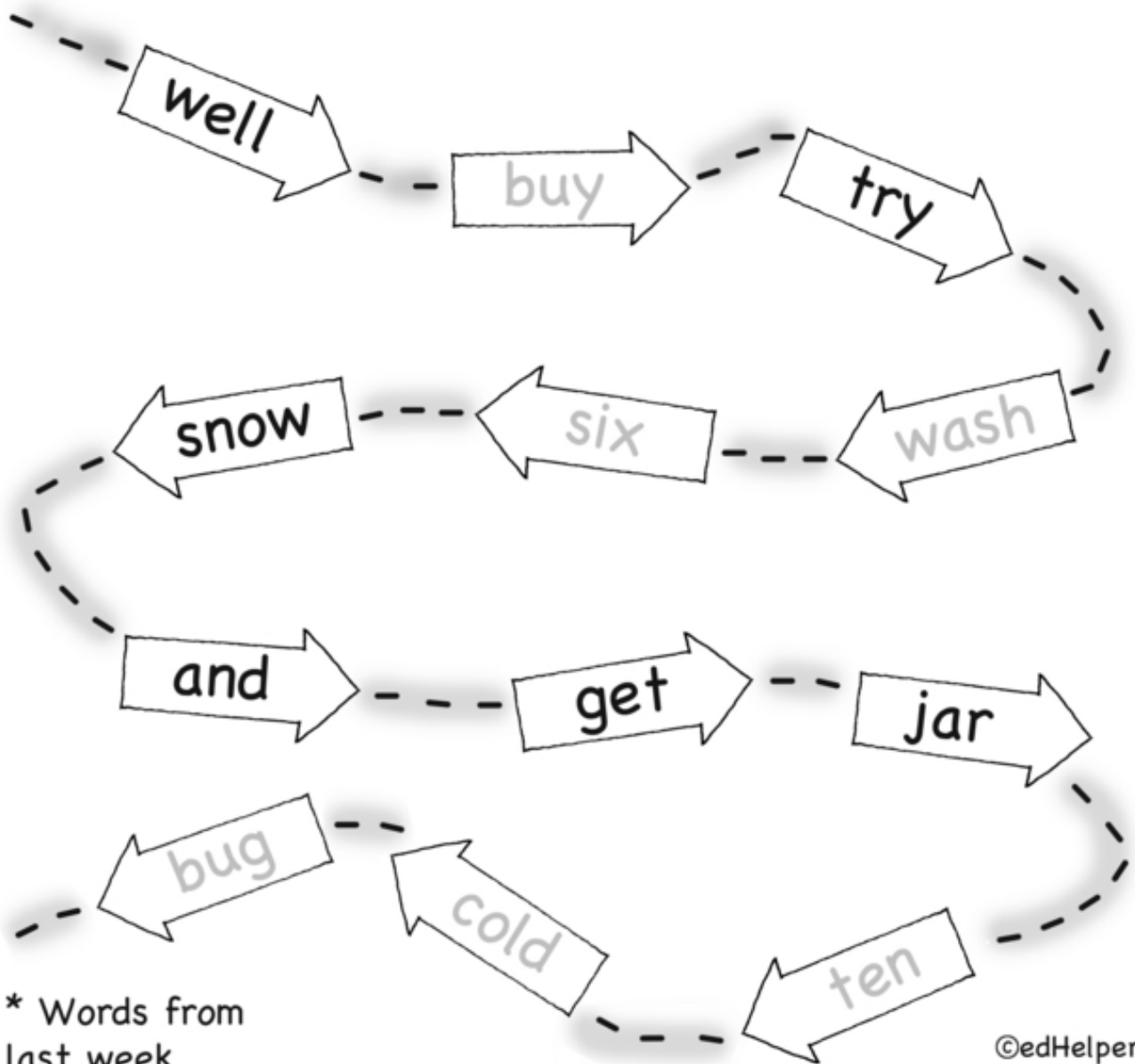

* Words from last week.

Name _____



Color...

and - red
try - green
get - blue

jar - pink
well - purple
snow - yellow

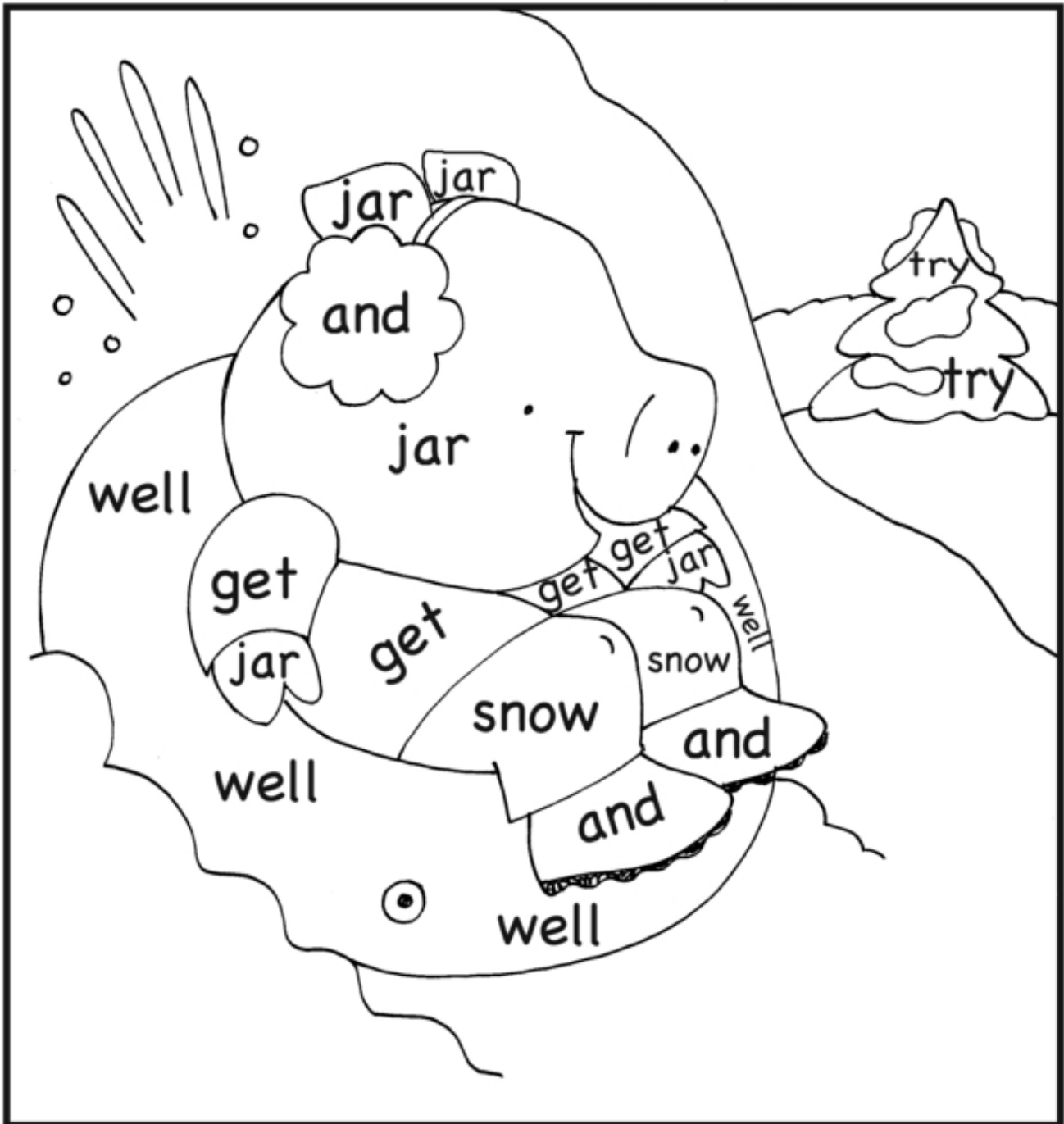

Name _____

Gift

Give

Week
14

Find the hat that has the same word list as the one in the box. Draw a box around it.

jar
snow
try
get
and
well

jar
snew
try
git
and
well

jor
snow
trry
geet
and
well

jar
snoow
tri
get
ann
well

jar
snow
try
get
and
well

jar
snow
try
grt
adn
well

Name _____

Sentence Sense



Point to the word that will fill the blank.

1. I am shoveling _____.
2. I want to _____ to clear the driveway.
3. That way Dad can _____ his car in the garage.
4. So I push _____ push the slushy mess!
5. Maybe I'll do so _____ Dad will give me a dollar.
6. I'd save it in my money _____.

and

try

get

well

jar

snow



Name: _____

Week 15
Kindergarten



pig

i p o g p q p w o **p i g** g e

many

q m a n y y a m m m m n a y



sled

c d d s l e d s l e e d m j

did

d u h d d d i d l q i e w v



new

n u o n e e w n n e w x j n



can

s n c a n k u n c c n p d b

Name: _____

Week 15
Kindergarten

Color in the boxes.

sled = yellow, pig = pink,

can = red, new = black,

many = purple, did = purple

What is the hidden number? _____

new	many	many	did	many	did	did
sled	did	can	new	can	new	did
pig	many	sled	pig	sled	pig	many
can	did	did	did	did	many	many
new	sled	pig	sled	can	new	did
pig	can	can	new	pig	sled	did
sled	new	pig	sled	can	new	did

Circle the spelling words.

manysledcandidnewpigsledpigdidcannewmanydid

didnewsledcanmanydidmanysledmanynewpigdidpig

sleddiddidmanypigcanpigcandiddidnewcanpignew

Name: _____

Week 15
Kindergarten

l d g f n a d h p g e m
c l e c a n e w r d g o
o d i d n c l m c l d h
c n c e t e p y s l e d
i c a d p l l g d m e n
o d n i j n w p c i e a
m n w d d g d e m a n y
n n e n n p i g d y l m



can ↓



sled →



new →



pig →

did ↓

many →

short e and long e

watermelon



beetle

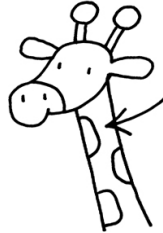

puppy

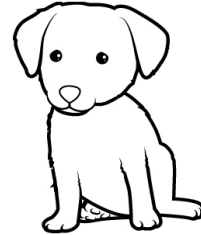

help

web

tree

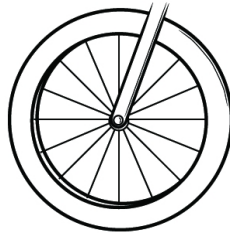
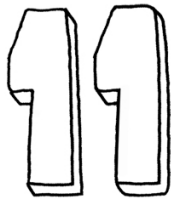

went

wheel

neck

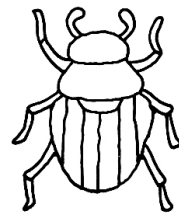

yellow

me

eleven

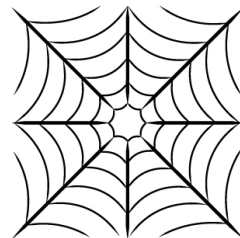
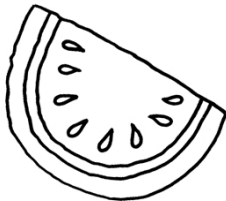

begins with s sound

begins with b sound

best

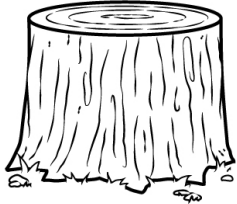

six



boxes

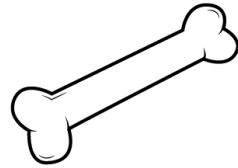

baby

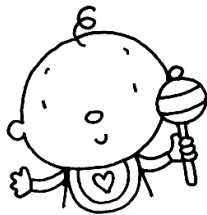

bone

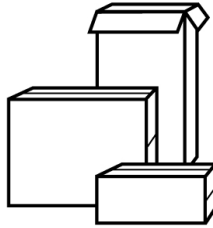

buy

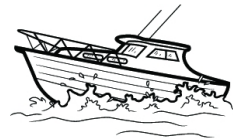

boat

bike

sound



said

stump

bears

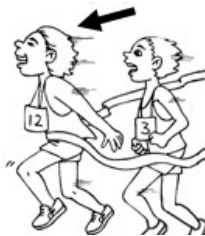
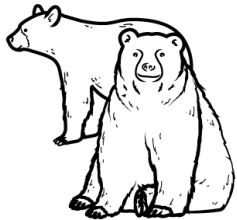

Name: _____

The first letter is ...

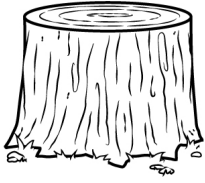

ump



oat

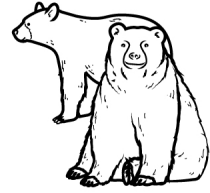

ears



ix



oby

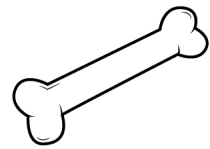

one



aid



est

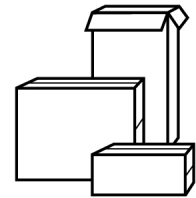

oxes



uy



ound



ike

Name: _____

edHelper



sound

d n k s o u n d u r s o u n g c q w d

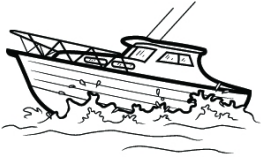

boat

t s b b j b o a t a a b o e t o r p a

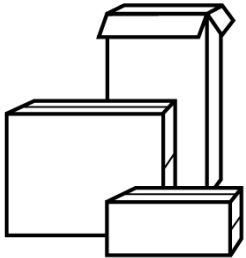

boxes

x b a x e s s j z b o x e s o q o s b



buy

y b y f b u y p h b i y b u k v n b o



best

e x e s q b e x t u b s t j b e s t t

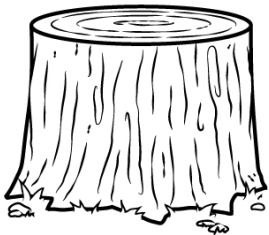

stump

s t u h m h s t u m p m l q e b r y s

Name _____

Sight Words

Week
15

Say them (in black) and repeat (in gray).

can  can can can can

new new new new new

did did did did

many many many many

 S-o-u-n-d It Out

pig  pig pig pig pig

W-i-n-t-e-r Word

sled  sled sled
sled sled

Name _____



Rapid Review

Week
15

Follow the arrows to say your new words (in black) and your *review words (in gray)!

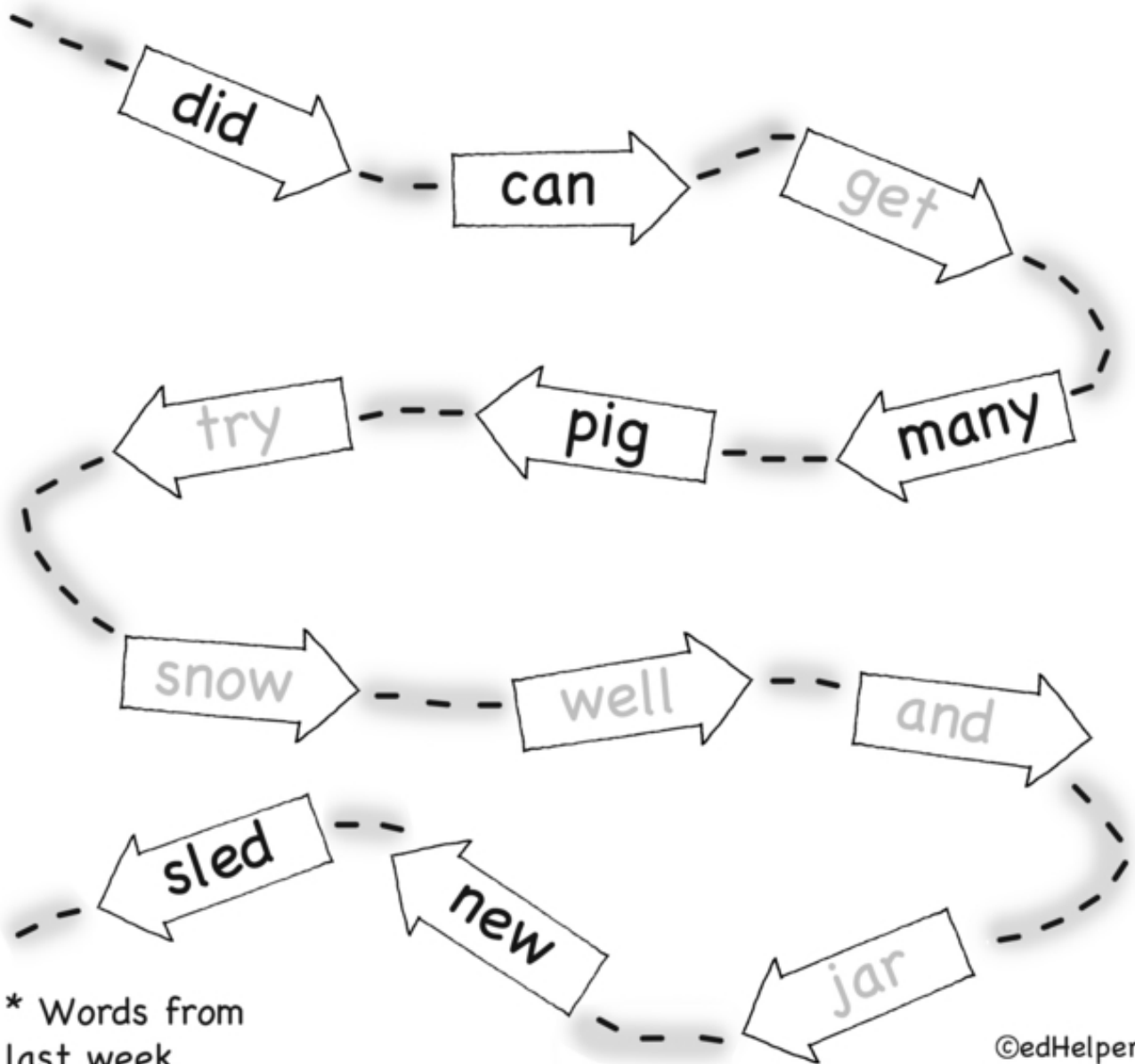

* Words from last week.

Name _____



Color...

can - blue pig - brown
new - green many - purple
did - yellow sled - red

Week
15



Name _____

Snowball Search

Week
15

Find and circle these words in the snowballs below.
Look up, down, and across.

sled pig many new can did

g	d	s	p	n	p
y	e	l	p	a	i
n	n	d	w	l	g
a	s	l	e	d	n
m	a	c	n	d	d
c	a	n	i	y	i
n	y	m	m	n	d

Name _____

Sentence Sense



Point to the word that will fill the blank.

1. Luke has _____ pets.
2. He just got a pot-bellied _____!
3. Everyone wants to see his _____ animal.
4. Luke puts it on his _____ and pulls it over to us.
5. That little hog sure _____ snort loud!
6. What Luke _____ was really nice!

can

new

did

many

pig

sled



Name: _____

Week 16
Kindergarten



ran

n a r r i n a **r a n** a l w n

how h g p d e u h o h u o h o w

any z s a n y v e u n y r y n o

been e s t b b e e n o b a h n e

sat t s a t s a t t a s x v o t



RAN

C V O N Y R A N N T S R E N

BEEN G T E B B I H N N E B E E N

ANY M O U U N Y A N Y V D G K B

SAT A S A T S U T S T L Z S X N

Name: _____

Week 16
Kindergarten

Color in the boxes.

been = pink, ran = orange,

any = pink, how = red,

sat = red

What is the hidden number? _____

sat	sat	how	how	how	how	ran
sat	any	ran	ran	ran	been	any
sat	ran	been	any	any	been	ran
sat	how	how	sat	how	sat	ran
how	any	any	ran	ran	how	any
how	ran	been	been	any	sat	ran
how	how	how	sat	how	sat	any

Circle the spelling words.

ranhowbeenanysathowrananysatbeenhownranbeen

howanyranbeensatrananyanyhowransatbeenhown

howhowbeenbeenbeenranranhowhowhowanyany

Name: _____

Week 16
Kindergarten

b a h o w t e t p g i b
e d a x a h y t b o t b
e n k a v e b e b s a t
n b e n e p h n e a r h
q m k n r n r e b r a a
q w x o r r e n n d n n
t t f y t e e g x t a y
i u e n f u s o o k t j



ran ↓

how →

any ↓

been ↓

sat →

short a and long a

cane



take



grapes



apple



vacuum

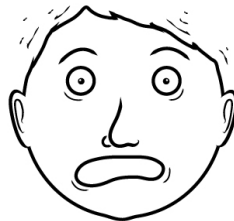

vase



hat



glasses



bag

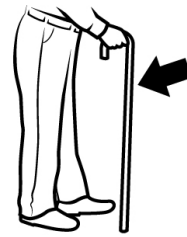

black



afraid



jack o lantern

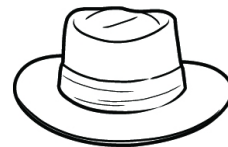

begins with g sound

begins with l sound

leg

leaf

live

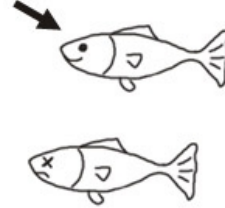
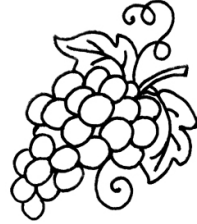

grow

look

girl

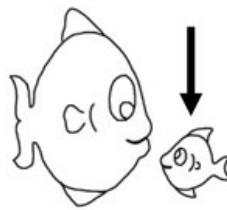
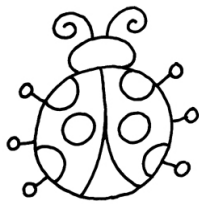

grapes

little

laugh

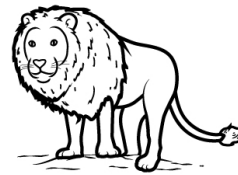

ladybug

lion

like

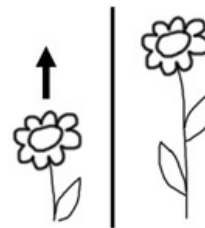

Name: _____

begins with g sound

begins with l sound

begins with g sound	begins with l sound	begins with l sound

Name: _____

The first letter is ...

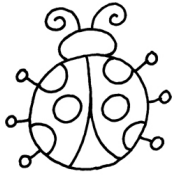

ladybug

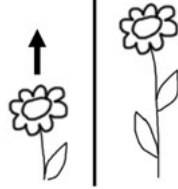

row



egg

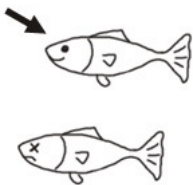

five

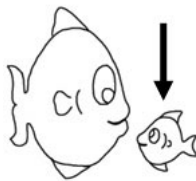

little



grapes



hug



look



leaf

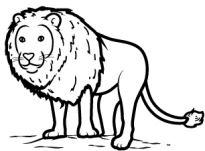

lion



like



girl

Name: _____

edHelper

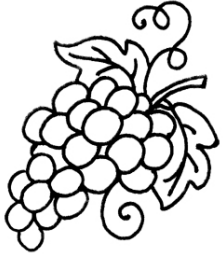

grapes

p s h i g g r a p e s p q g r a p s a



laugh

j l a u g h t h l a e l a u g h u g n



leg

y j e z p l i g t w l e g e l d n v l



like

e a l i k e l s l v i k f g b l i e k

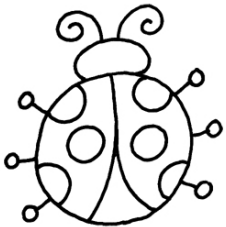

ladybug

c l a d y b u g g l a y d e a b u h g



girl

g e r l g i r l d h j g l g v c r m i

Name _____

Sight Words

Week
16

Say them (in black) and repeat (in gray)!

ran  ran ran ran ran

how how howhow how

any any any any any

been been been been been

 S-o-u-n-d It Out

sat  sat sat sat sat

Name _____



Color...
ran - purple
how - yellow
any - blue
sat - brown
been - black

Week
16

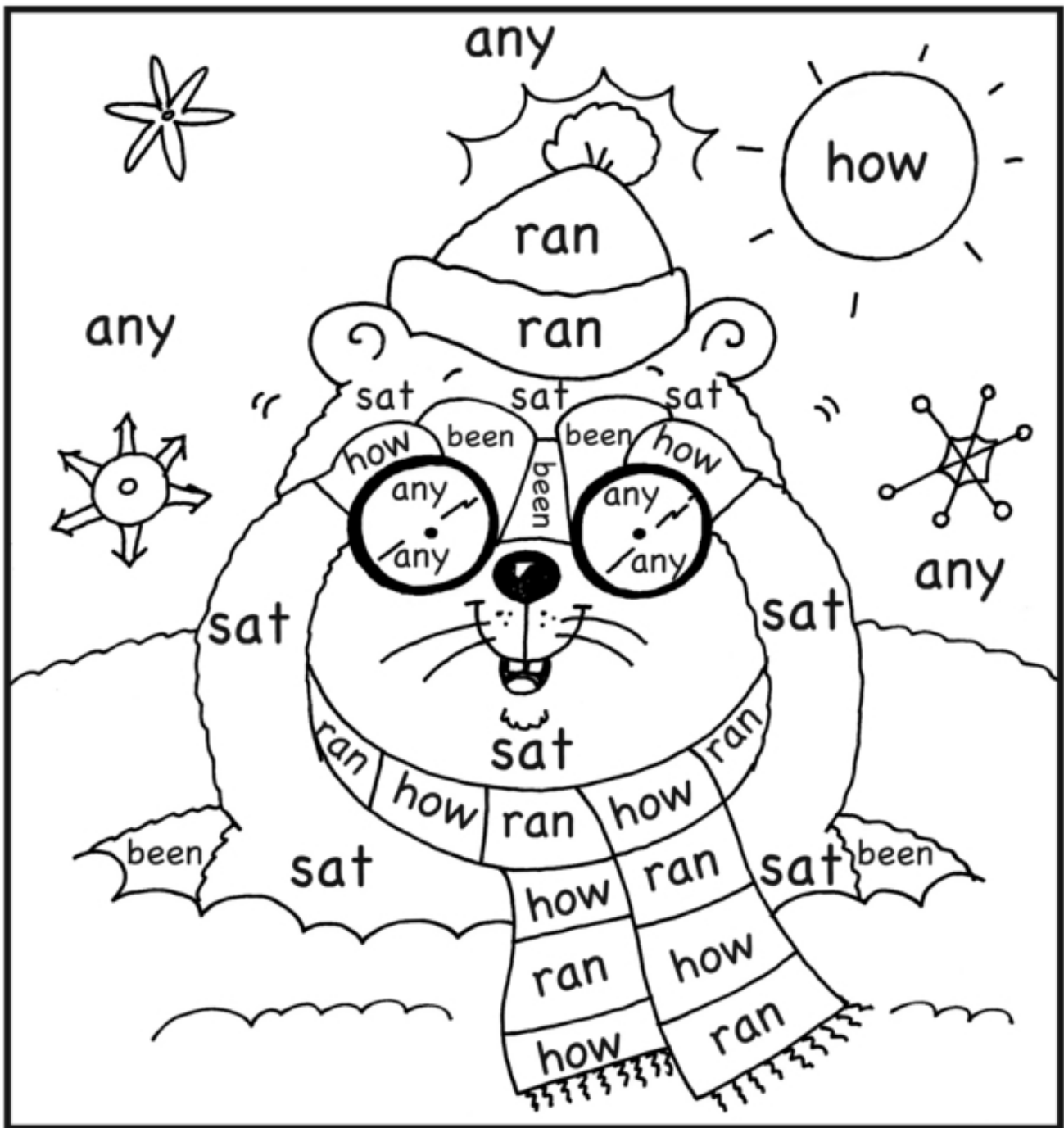

Name _____

Shady

Shadows

Week
16

Shade in the shadows with words that do not match those on the snowbank.

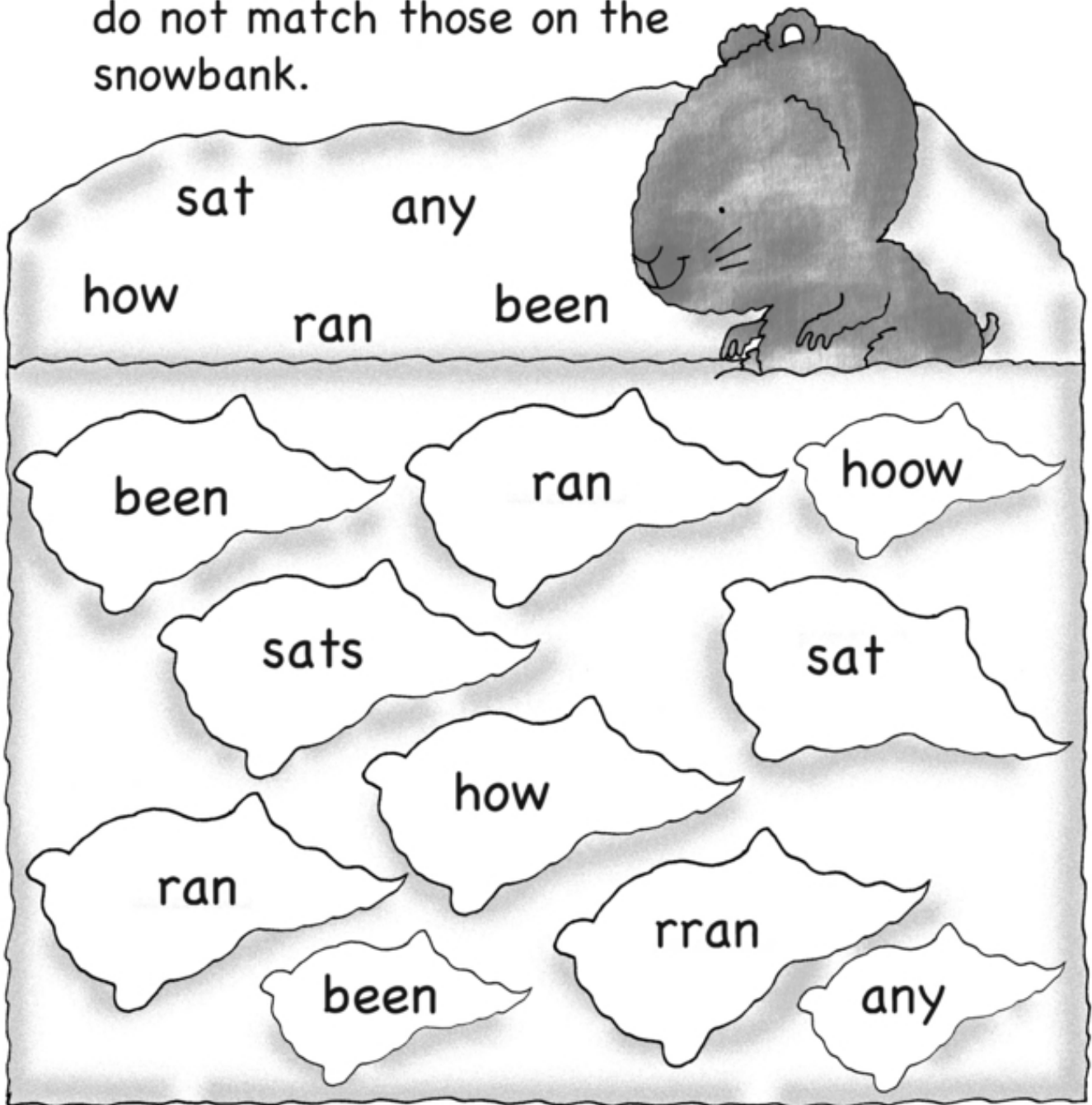

Name _____

Sentence Sense



Point to the word that will fill the blank.

1. I had _____ craving soup.

2. Mom said we didn't have _____.

3. We _____ out last week.

4. Dad taught me _____ to mix up a batch.

5. Later, we _____ down and had big bowls full!

ran

how

any

sat

been

