





Name: \_\_\_\_\_

Week 9  
Kindergarten



no

s z n o h j x **n o** h o o o d

of o j p o f d c q f r f o h v

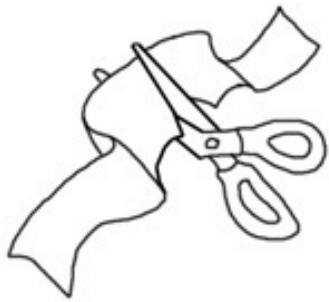

cut

r n f l c u t y g h k u h t

now l r w j b n e u n o w k f n

hop h s h o p z h o p p p o q r



NO

E G O N O K N O O H U J T O

OF F D F S O T U F Z C A L O F

Name: \_\_\_\_\_

Week 9  
Kindergarten

Color in the boxes.

no = pink, cut = purple,

now = green, hop = green,

of = orange

What is the hidden number? \_\_\_\_\_

cut	of	now	of	cut	no
no	cut	now	no	of	no
of	no	hop	cut	no	cut
no	cut	hop	of	of	of
of	of	now	no	no	cut
cut	no	now	cut	of	no

Circle the spelling words.

nownohopcutofhopofnocutnowcutnowhopofnocut

hopnoofnohopnowofcutnocutcuthopnownowofcut

hopnocutnowcutcuthophophopnownowcutnow



Name: \_\_\_\_\_

Week 9  
Kindergarten

n q n a h o u h p n o w  
h h o p o n p h f o h n  
n o u s l n o o o g y x  
f b k o f p f h w n a l  
o a n c u t m u o t o u  
h o o m m p w o u o o o  
w o y v d h o o t u h o  
u y z u o h u n u n t f

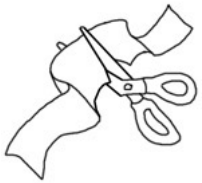

cut



no



hop →

of →

now →

short i and long i

fish

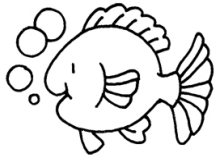

light



wish

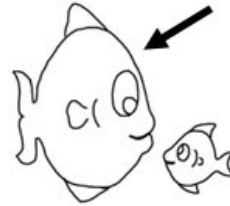

rings

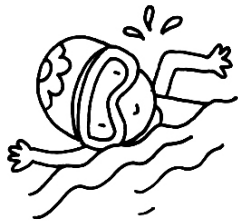

zipper



sidewalk



his

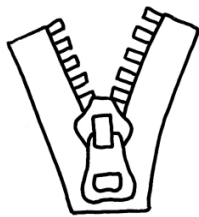

wig

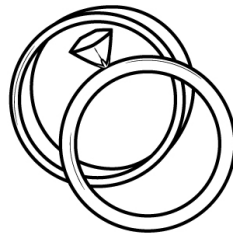

in



big



ring



swim





begins with h sound

begins with k sound

can

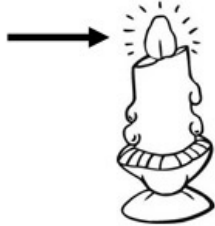

cook



hot



he

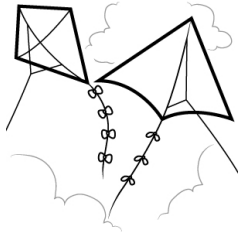

crown



kites



kind



comb

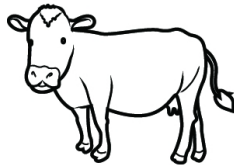

cloth



crib



cow



queen



Name: \_\_\_\_\_

begins with h sound

begins with k sound

begins with h sound	begins with k sound	begins with k sound

Name: \_\_\_\_\_

The first letter is ...



\_\_\_\_\_

\_\_\_\_\_

e



\_\_\_\_\_

\_\_\_\_\_

ri



\_\_\_\_\_

\_\_\_\_\_

an



\_\_\_\_\_

\_\_\_\_\_

in

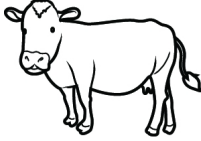

\_\_\_\_\_

\_\_\_\_\_

ow

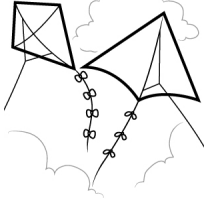

\_\_\_\_\_

\_\_\_\_\_

ite



\_\_\_\_\_

\_\_\_\_\_

oo



\_\_\_\_\_

\_\_\_\_\_

om

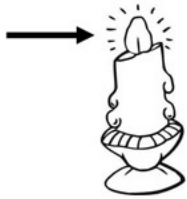

\_\_\_\_\_

\_\_\_\_\_

ot



\_\_\_\_\_

\_\_\_\_\_

ue



\_\_\_\_\_

\_\_\_\_\_

oth

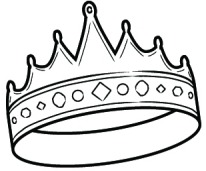

\_\_\_\_\_

\_\_\_\_\_

rown

Name: \_\_\_\_\_

edHelper

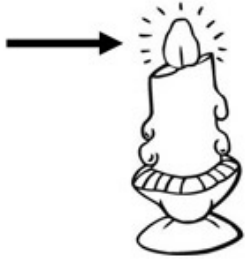

hot

h o t t a f e x y d s n h o t o i o o

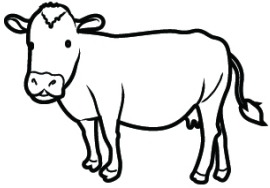

cow

r w w u h j l c i w w c o w c o o o n

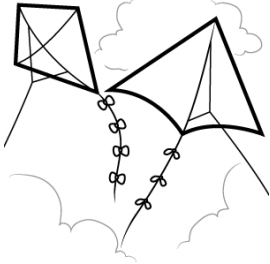

kites

s u j t k k d k i t e s k i t i s e f



cloth

c o l e c l o t h k l a w t h q l o o



cook

o c o o k k j c l k c c e o k w t k n



he

m j e e v g e e c h e h h u a h h e e

Name \_\_\_\_\_

# Sight Words

Week  
9

Say them (in black) and repeat (in gray).

of of of of of

no no no no no

cut  cut cut cut cut

now now now now now

 S-o-u-n-d It Out

hop  hop hop hop hop



Name \_\_\_\_\_



# Rapid Review

Week  
9

Follow the arrows to say your new words (in black) and your \*review words (in gray)!

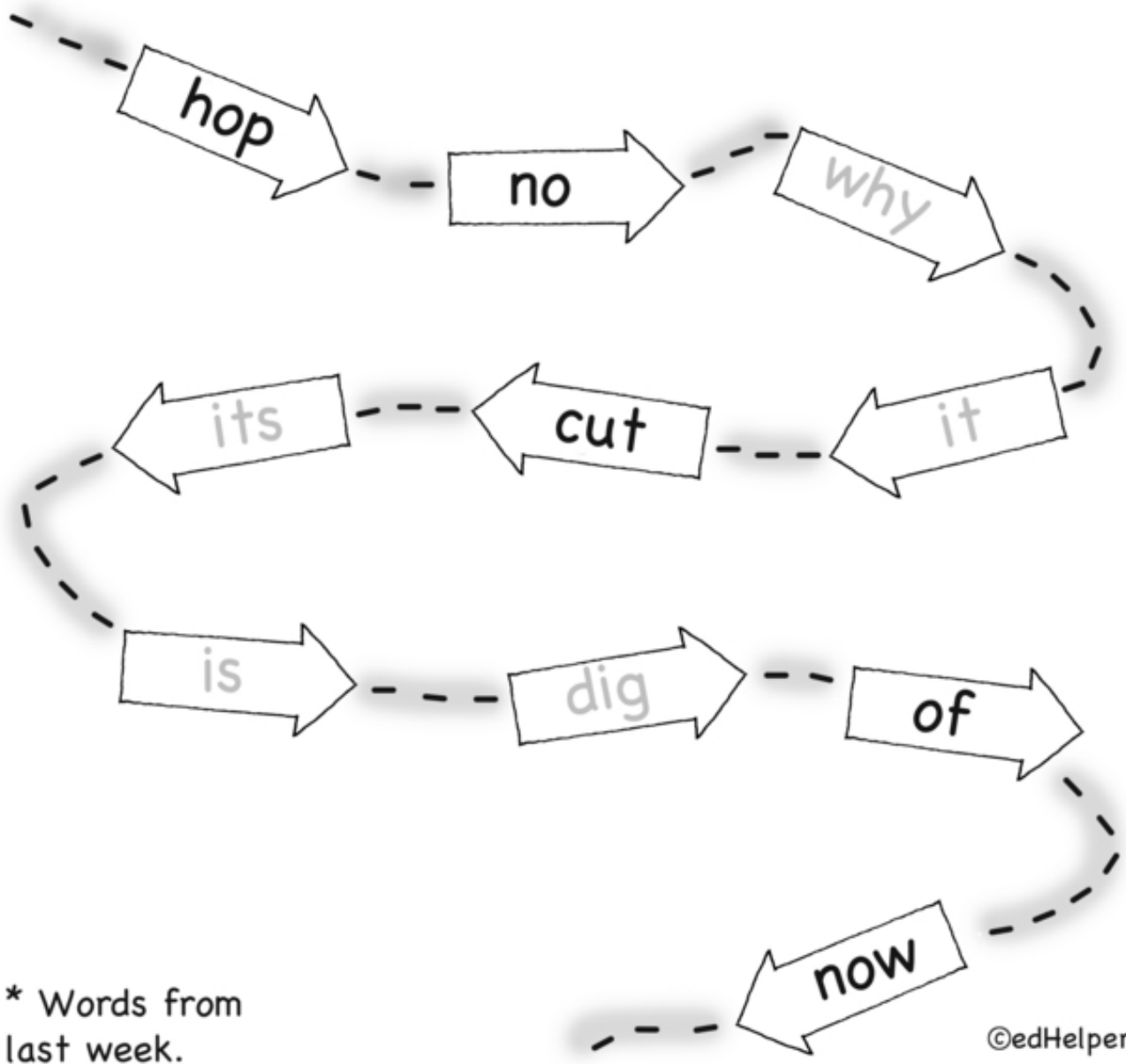

\* Words from last week.

Name \_\_\_\_\_

Scattered Scarves

Week  
9

Put an "X" over any of the small scarves that don't have words that match those on the top one.

now of cut hop no

hop

cut

off

new

now

hep

no

cot

no

of

hop

of

no

now

noo

cut

Name \_\_\_\_\_

## Sentence Sense



Point to the word that will fill the blank.

1. Our baby bunny can \_\_\_\_\_ fast!

of

2. She wants a bite \_\_\_\_\_ my carrot.

no

3. There's \_\_\_\_\_ way!

cut

4. Instead, I \_\_\_\_\_ a piece off.

now

5. We both have a snack \_\_\_\_\_!

hop







Name: \_\_\_\_\_

Week 10  
Kindergarten



**in**

g **i n** x i h d l i k j e h n

**jaw**

j i w i v u n p w c j a w a

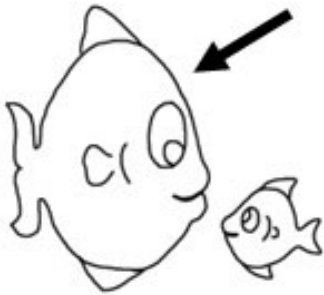

**big**

b o h g s t b i g j b g g d



**on**

o n t a w h o y o n n v e m



**red**

d e r i h d k p e j y r e d

Name: \_\_\_\_\_

Week 10  
Kindergarten

Color in the boxes.

jaw = purple, on = blue,

big = green, in = red,

red = orange

What is the hidden number? \_\_\_\_\_

on	in	jaw	big	on	in
red	big	on	jaw	red	jaw
red	jaw	in	on	red	on
red	on	big	jaw	red	jaw
red	red	red	red	red	red
jaw	on	jaw	on	red	in
in	big	in	big	red	big
big	on	jaw	on	red	on

Circle the spelling words.

inredjawonbigonredbigjawinjawinredonbigjawredin  
bigredonininredjawjawredredonjawininbiginonjawin  
bigonredjawjawinjawonbigredinonjawinbigredjawin

Name: \_\_\_\_\_

Week 10  
Kindergarten

f b g o o g p o n j a b  
o r b o a n r x q a a i  
i i w n r i n e w w o g  
o o o j a d y w k a m a  
r d m n i w n r g n t j  
f r f a s j z z j u r b  
w i g f x u b r w d e j  
m i b n b l o n n k d y



red ↓



in  
→

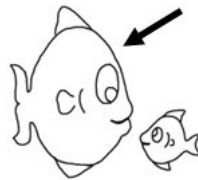

big ↓



on  
→

jaw ↓



web



cherries

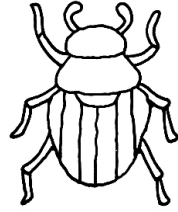

leg



tree

leaf

ten

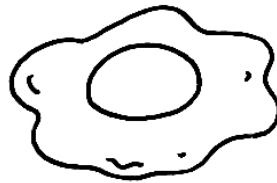
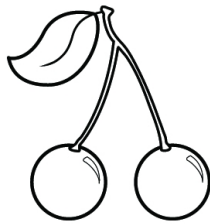

money

queen

beetle

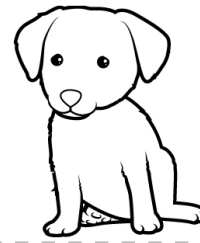
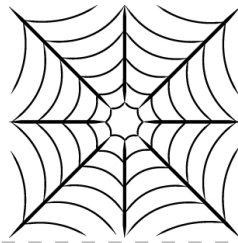

egg

puppy

smell



10





begins with b sound

begins with j sound

bank



basketball



buy



jump



big



bag

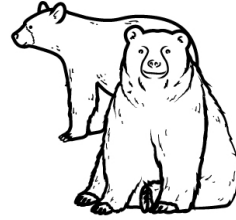

jack o lantern



bucket



bears

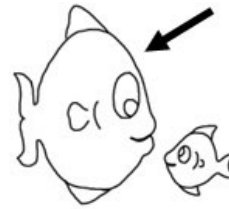

boy

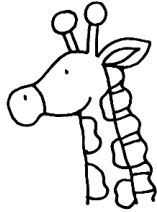

bite



giraffe

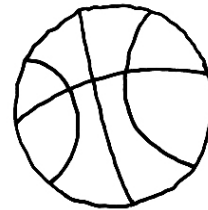

Name: \_\_\_\_\_

begins with b sound

begins with j sound

begins with b sound	begins with b sound	begins with j sound

Name: \_\_\_\_\_

# The first letter is ...



ucket



iraffe



ump



uy



asketball

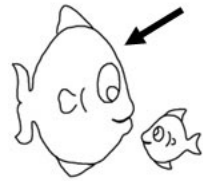

ig



ite



ag



oy



ears



ank



ack o lantern

Name: \_\_\_\_\_

edHelper

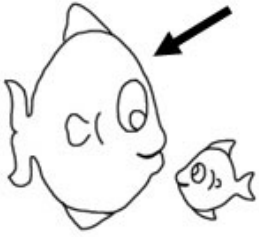

big

h x b i i h g u g i b g j d f b i g b

jack o lantern

j t j a c k o l a n t e r n x e

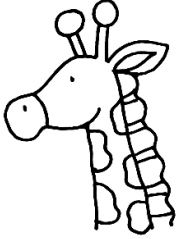

giraffe

f g g i r a f f e i g i r r a f f e g



bite

b i t e d q n s g y i t v b i t e b e



buy

i b b f h b b t y u b u y b b e i b y



bears

e h b e r s e b e s a o b e a r s r s



boy

b q o d r o i v b o y b w e o y b u i

Name \_\_\_\_\_

# Sight Words

Week  
10

Say them (in black) and repeat (in gray).

in in in in in

on on on on on

big big big big big

red red red red red



S-o-u-n-d It Out

jaw



jaw jaw jaw jaw

Name \_\_\_\_\_



# Rapid Review

Week  
10

Follow the arrows to say your new words (in black) and your \*review words (in gray)!

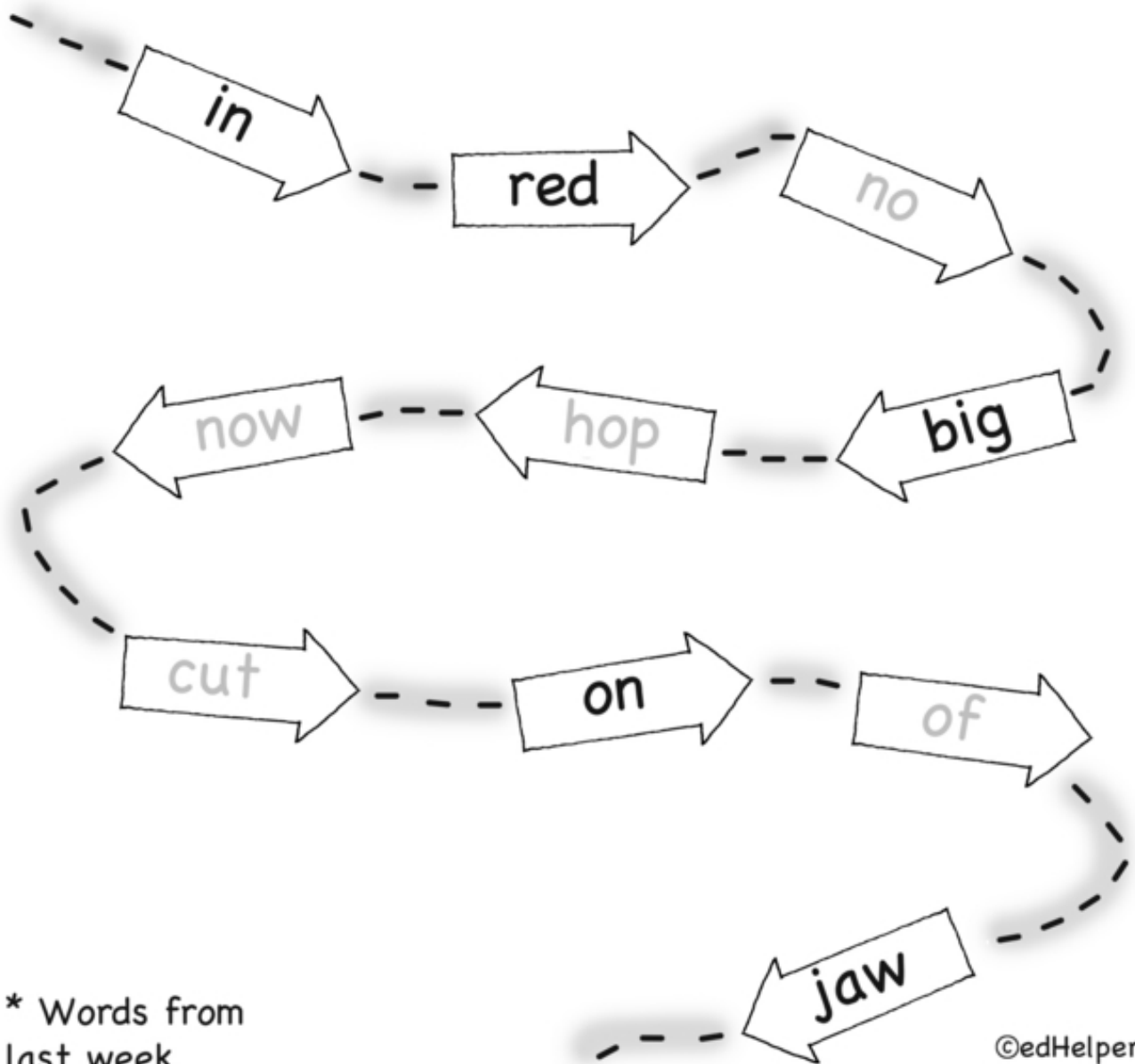

\* Words from last week.



Name \_\_\_\_\_



Color... in - yellow  
on - pink  
big - black  
red - green  
jaw - blue

Week  
10

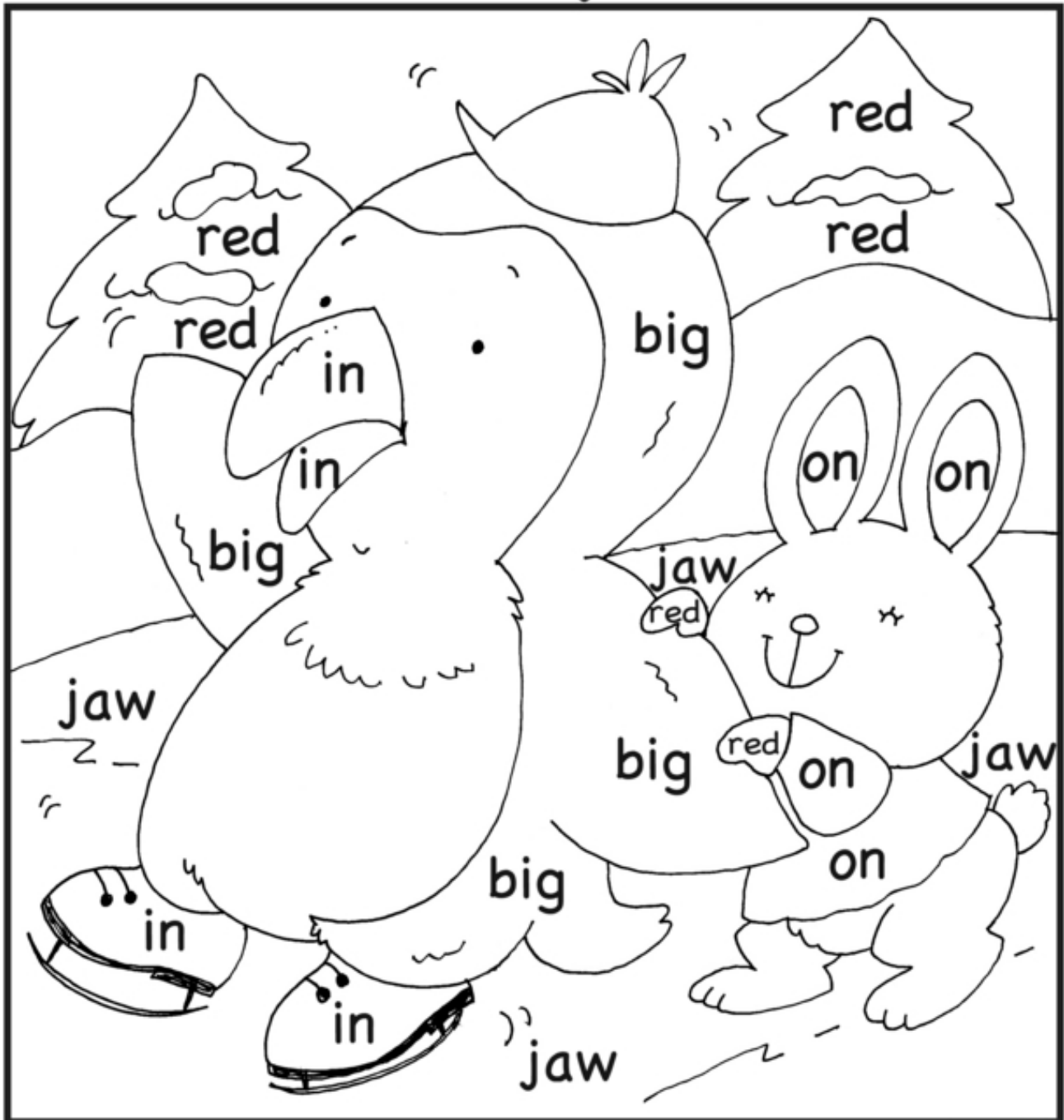

Name \_\_\_\_\_

**Fake** **Flakes**

Week  
**10**

Find the snowflakes with words that are not spelled correctly. Write a big "F" (for "fake") on them.

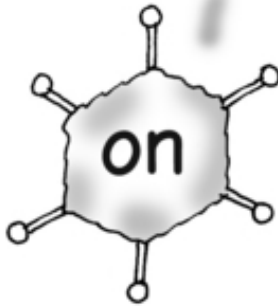
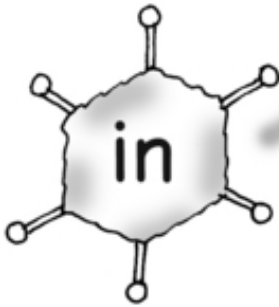

Name \_\_\_\_\_

## Sentence Sense



Point to the word that will fill the blank.

1. There was a \_\_\_\_\_ snowstorm!

in

2. We all stayed \_\_\_\_\_.

on

3. I wore my \_\_\_\_\_ pajamas.

big

4. I watched funny cartoons  
\_\_\_\_\_ that day.

red

5. I laughed so much my \_\_\_\_\_  
got sore!

jaw







Name: \_\_\_\_\_

Week 11  
Kindergarten



cup

r k u p f p c **c u p** p z m v

all e w l u a l l h l e w s q k



ate

e a t e b h e a m a o y t e

use o u j k w l u s e y u o s m

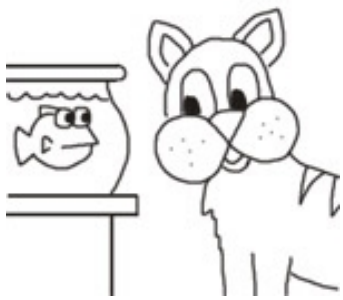

want

w n n w x w a n t w a n n a

boots o s b o o t s o b o t t s p

Name: \_\_\_\_\_

Week 11  
Kindergarten

Color in the boxes.

want = purple, ate = yellow,  
boots = green, use = yellow,  
all = blue, cup = black

What is the hidden number? \_\_\_\_\_

boots	want	boots	use	ate	use	boots
cup	cup	use	want	cup	want	use
all	boots	use	boots	all	boots	ate
want	cup	use	cup	want	cup	ate
boots	all	use	all	boots	all	ate
want	cup	use	want	cup	want	ate
all	boots	all	use	ate	ate	cup

Circle the spelling words.

cupatebootswantuseallatebootscupwantuseallallcup  
cupbootscupbootswantateuseallallateusebootssateall  
wantatecupcupatecupbootscupwantuseallcupateall

Name: \_\_\_\_\_

Week 11  
Kindergarten

h b t u b c t a m u a s  
f u n s e n t b l j o l  
e t t e i b o a t e o u  
c u p a c w c f a u a h  
c z l j o l b o o t s f  
z t a a e a w a n t e n  
d a w l a t q o u w a e  
w p o l z t l u a p s e



cup



use ↓



ate



boots →



want



all ↓



short u and long u

pizza



koala



woman

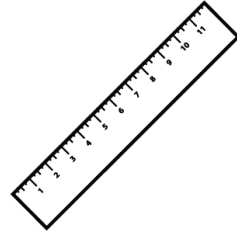

boot



seven



ruler

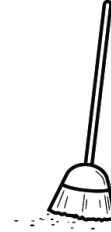

broom

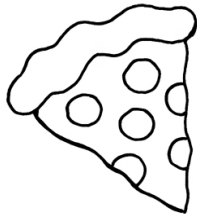

new



stool



zebra



cut

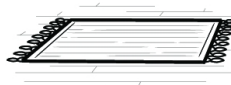

rug





begins with w sound

begins with s sound

window



sink



socks



worm



web

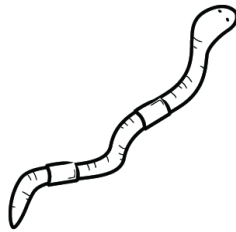

wind

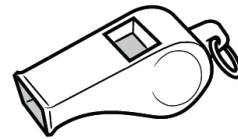

whistle



water

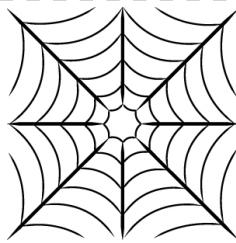

went



woman

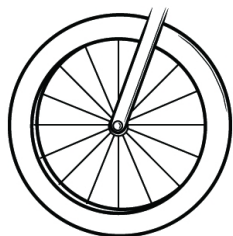

well

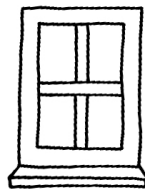

wheel



Name: \_\_\_\_\_

begins with w sound

begins with s sound

begins with w sound	begins with w sound	begins with s sound

Name: \_\_\_\_\_

# The first letter is ...



ater



oman



ind

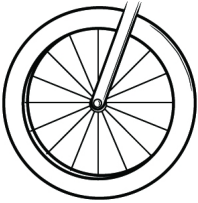

heel



ent

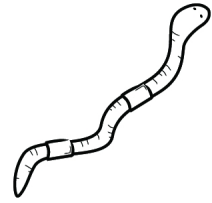

orm

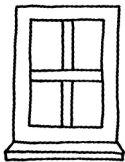

indow

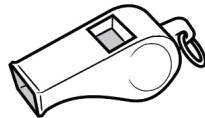

histle



ell



ink



ocks

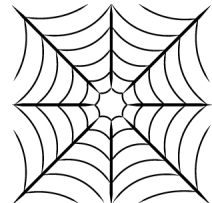

eb

Name: \_\_\_\_\_

edHelper



socks

o s o c k s v b s o s g s s o a c k s

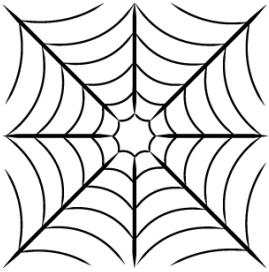

web

t l b e w e b e w e w w u b d z y b w



sink

s i n k s i k s l v s c n k s k w n k



went

t n b w k w e n t f v w e h t t w w p



woman

m o n a a n w u m u n o w t w o m a n

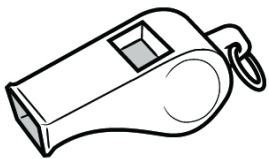

whistle

h r t h w w i s t l e w h i s t l e l

Name \_\_\_\_\_

# Sight Words

Week  
11

Say them (in black) and repeat (in gray).

ate

ate ate ate ate

all



all all all all

use

use use use use

want want want want



S-o-u-n-d It Out

cup



cup cup cup cup

W-i-n-t-e-r Word

boots



boots  
boots

boots  
boots

Name \_\_\_\_\_



Color...

ate - yellow    cup - black  
all - blue      want - green  
use - purple    boots - light pink

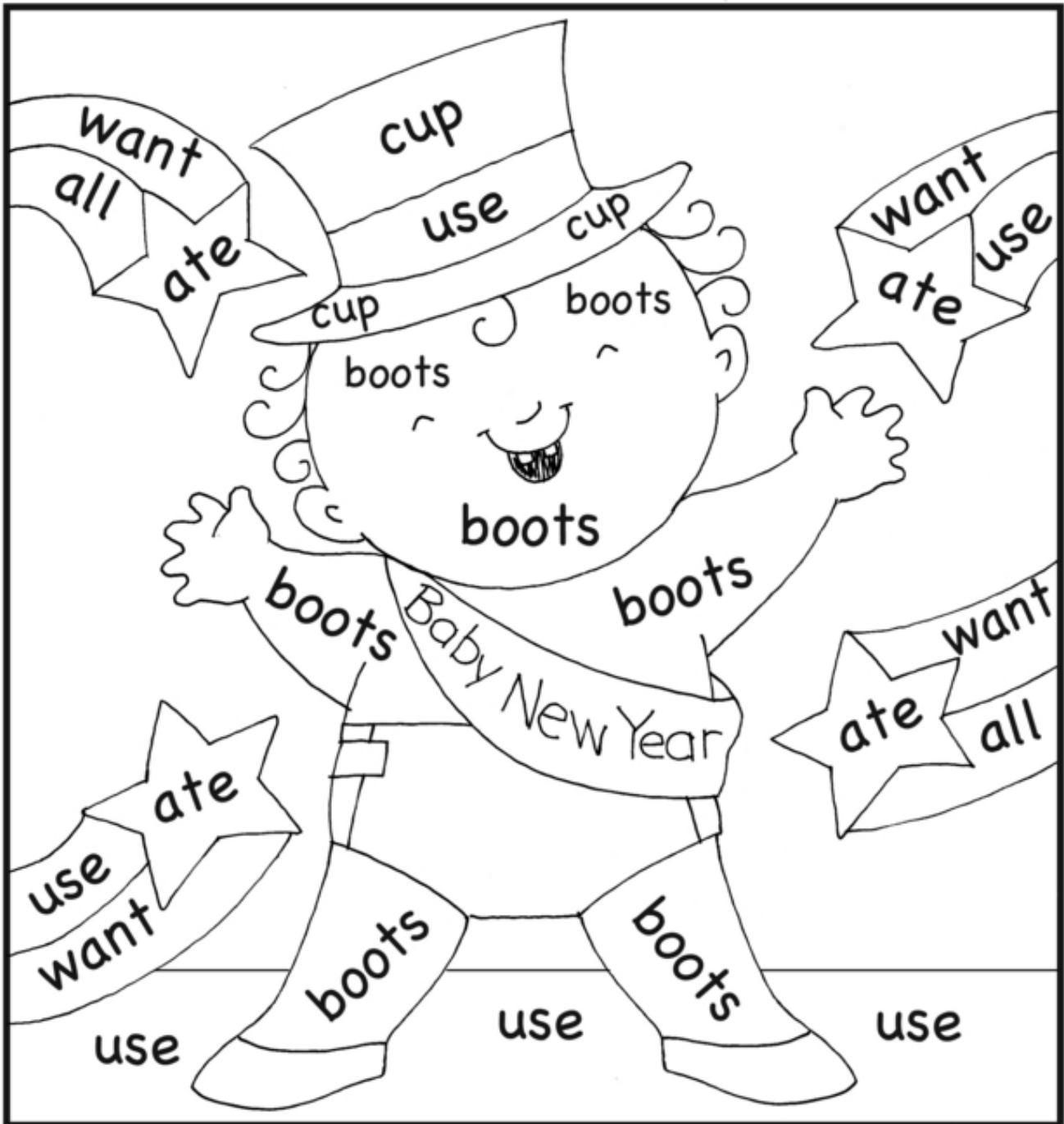



Name \_\_\_\_\_

Happy

Horns

Week  
11

Draw lines from the center words to the horns with those same words.



want  
boots

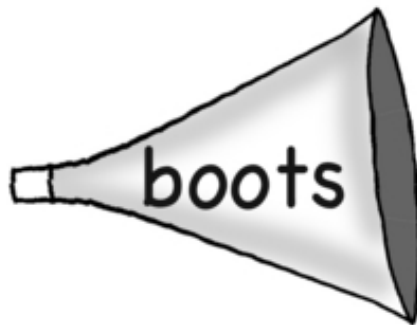
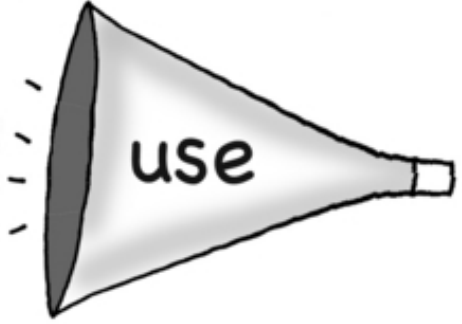

cup  
ate

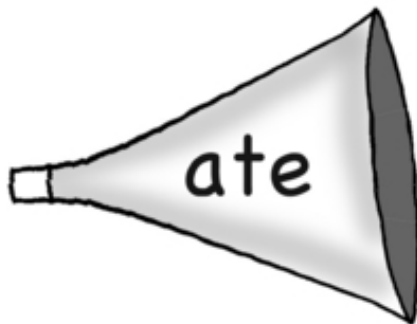

use  
all



Name \_\_\_\_\_

## Sentence Sense



Point to the word that will fill the blank.

1. I was bored \_\_\_\_\_ day.
2. I drank a \_\_\_\_\_ of juice.
3. Then I \_\_\_\_\_ some popcorn.
4. I knew I could \_\_\_\_\_ some exercise.
5. I \_\_\_\_\_ to stay healthy!
6. So I put on my \_\_\_\_\_ and went outside!

ate

all

use

want

cup

boots







Name: \_\_\_\_\_

Week 12  
Kindergarten



eat

g e e t t r z **e a t** t t b a

fix i b f i x x a e r f i f i x



she

h c s h e p s h u e e g r k

ice i c e i i s s n i c p i j c



run

r u n n r u n r r u o n u c



goes

g i z g o e s e e g o e p o

Name: \_\_\_\_\_

Week 12  
Kindergarten

Color in the boxes.

run = orange, ice = red,  
eat = green, she = green,  
goes = orange, fix = pink

What is the hidden number? \_\_\_\_\_

run	goes	goes	run	goes	eat	fix
run	ice	eat	ice	fix	ice	fix
run	fix	fix	eat	eat	ice	she
run	goes	goes	run	goes	ice	fix
fix	ice	fix	eat	fix	goes	she
she	eat	fix	ice	ice	run	ice
goes	run	goes	run	run	fix	she
ice	fix	ice	fix	she	ice	eat
eat	she	she	ice	ice	fix	ice

Circle the spelling words.

eaticerunshesfixgoesicerungoeseatshesfixshesfixeatrun  
goessheeatfixshesfixeateatshegoesicegoesicefixrunfix  
eatfixicegoesgoeseatsherungoesfixrunicefixfixgoes

Name: \_\_\_\_\_

Week 12  
Kindergarten

s x i u a o p c n r u e  
g x e i c e u r u n s g  
i r t j h i e t s h e g  
u r i k t c e o t t i o  
e t f r f x a m q s h e  
h e s s g t i z m r s s  
e e y f i x n f x u a y  
t r n i k x o v e a t o



eat



goes ↓



she



run



fix →

ice →

short o and long o

cone

yellow

watch

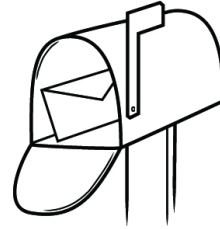

not

coat

note

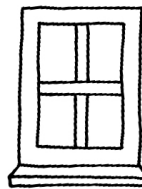
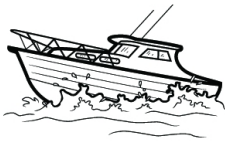

boat

rock

roses



toast

mailbox

window

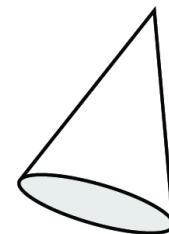
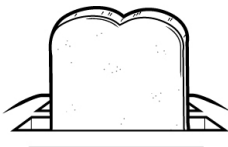





begins with f sound

begins with g sound

flower

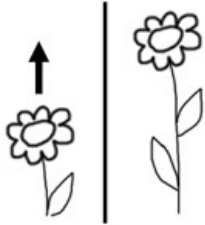

grow



green



going



gave



goose



glove



good



funny



globe

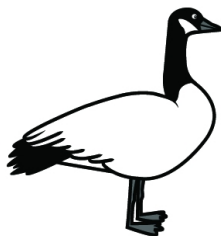

get



fin



Name: \_\_\_\_\_

begins with f sound

begins with g sound

begins with f sound	begins with g sound	begins with g sound

Name: \_\_\_\_\_

# The first letter is ...



ave



oing

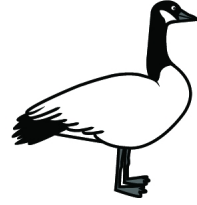

oose



ood



reen



lobe



lower



unny



love

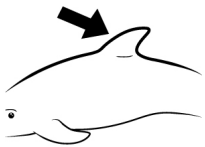

in



et

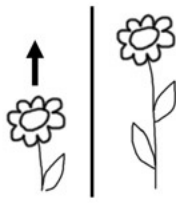

row

Name: \_\_\_\_\_

edHelper



**glove**

k m c g g l o v e l e r g o l v e u l



**flower**

o o y f l o w e r w j r g k f l o w r



**green**

y e q g r o e n g r e e n i l e e r k

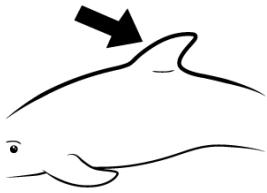

**fin**

y f i n f i h n d w p c h a f m n v j

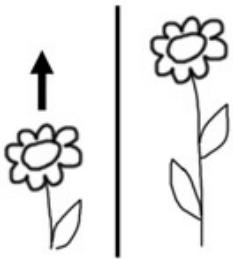

**grow**

m g h g r o w e v o b q f g r o w g r



**gave**

a w g v e g i v a a e g a t f g a v e

Name \_\_\_\_\_

# Sight Words

Week  
12

Say them (in black) and repeat (in gray).

run 

run run run run

she 

she she she she

eat 

eat eat eat eat

goes goes goes goes goes

 S-o-u-n-d It Out

fix

fix fix fix fix

W-i-n-t-e-r Word

ice



ice ice ice ice

Name \_\_\_\_\_



# Rapid Review

Week  
12

Follow the arrows to say your new words (in black) and your \*review words (in gray)!

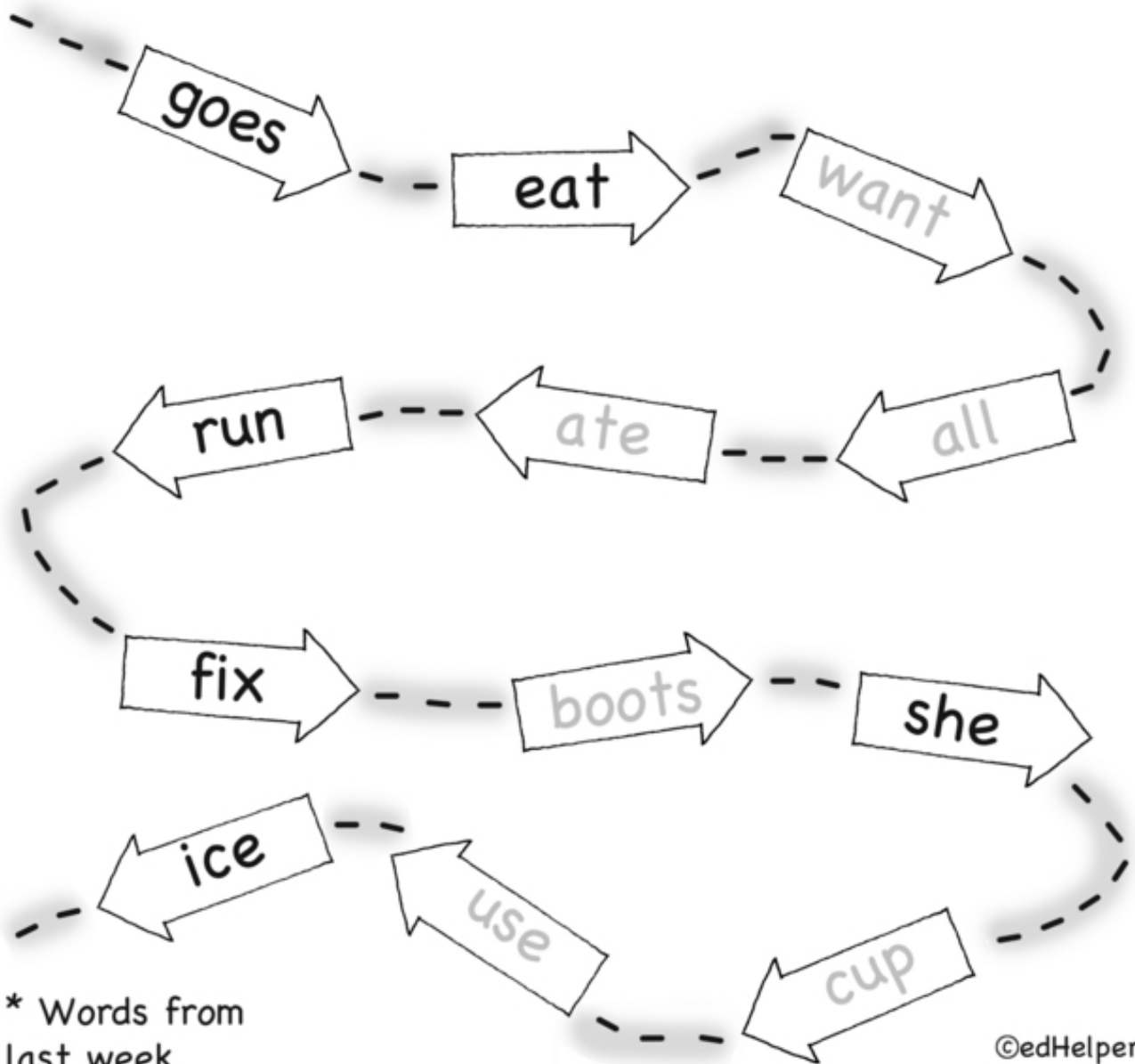

\* Words from last week.

Name \_\_\_\_\_



Color...

run - yellow    fix - black  
she - dark blue    goes - orange  
eat - green    ice - blue

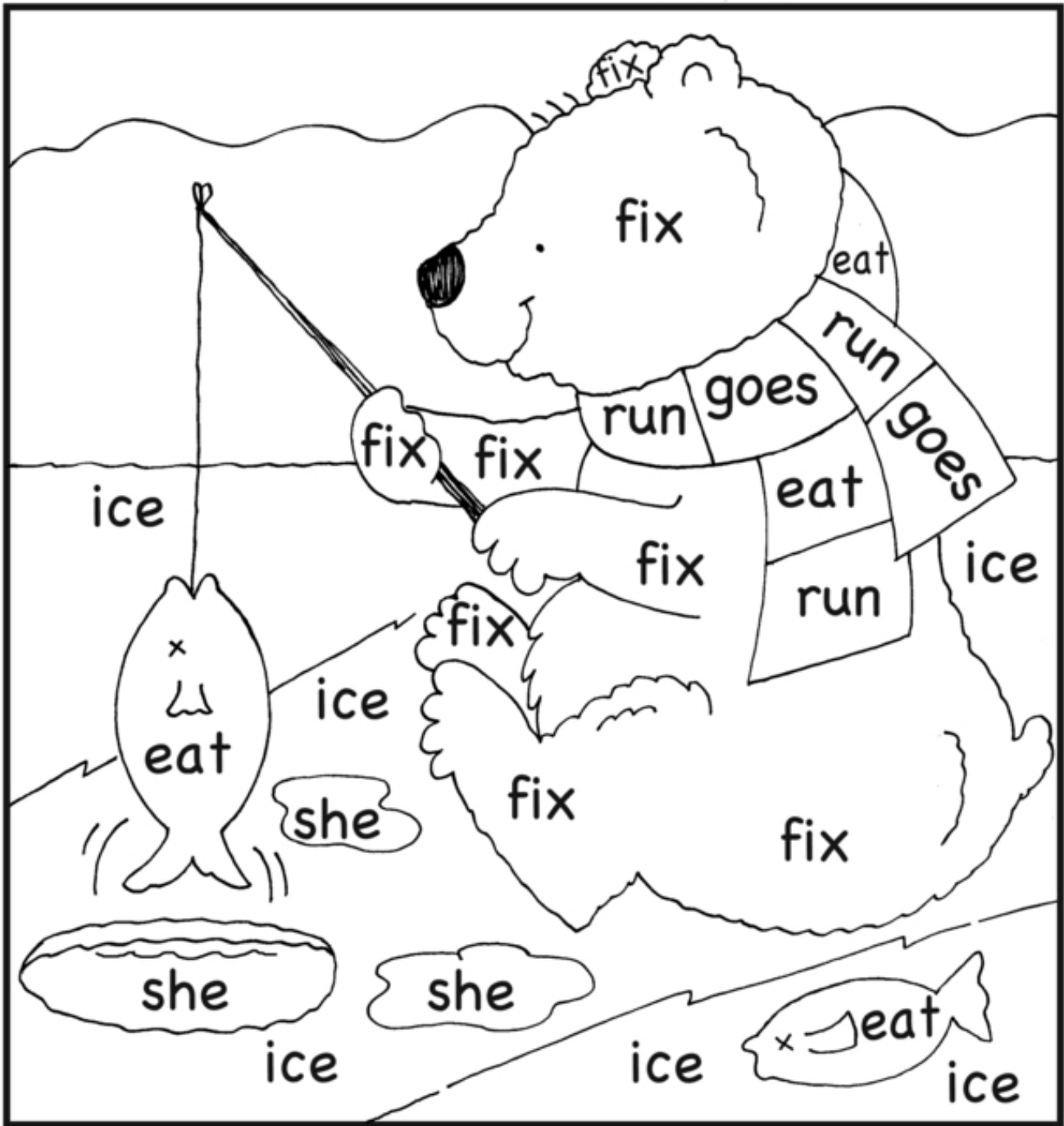



Name \_\_\_\_\_

Ready Confetti

Week  
12

Cut out the confetti with vowels at the bottom.  
Glue them with the letters to spell this week's words.

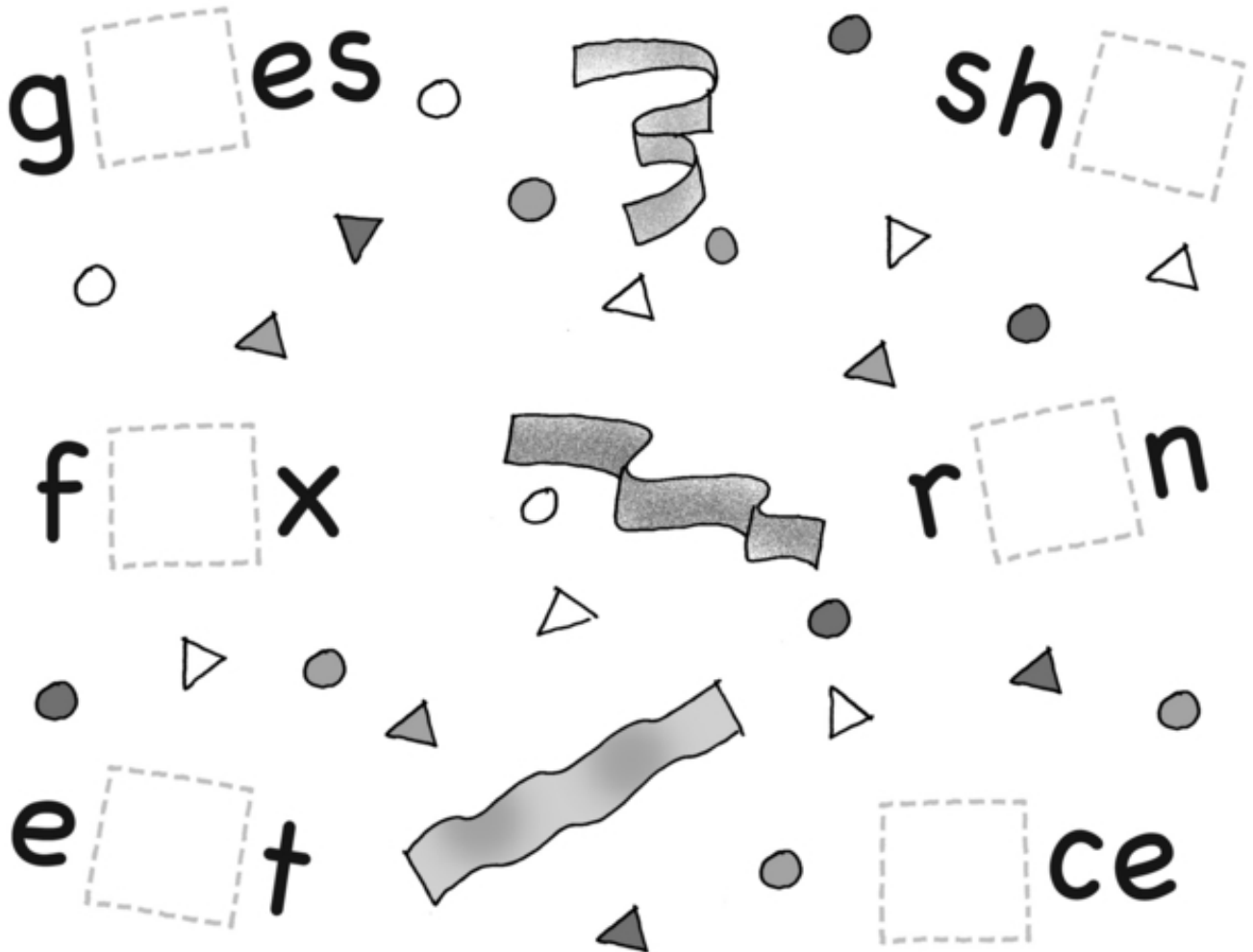

a e o i u i

Name \_\_\_\_\_

## Sentence Sense



Point to the word that will fill the blank.

1. After we \_\_\_\_\_, we can play in the gym.

run

2. Luke \_\_\_\_\_ to find a ball.

she

3. It's flat and someone needs to \_\_\_\_\_ it!

eat

4. Sadie decides to \_\_\_\_\_.

goes

5. The floor is as slippery as \_\_\_\_\_!

fix

6. Then \_\_\_\_\_ falls and just laughs!

ice

